**User's
Manual**



**Model DX2004/DX2008/DX2010/DX2020/
DX2030/DX2040/DX2048**

**Daqstation DX2000
Operation Guide**

vigilantplant.™



Contents

Foreword	3
Safety Precautions	3
Handling Precautions of the DX	4
Handling Precautions of the External Storage Medium (CF Card)	4
Checking the Contents of the Package	5
Conventions Used in This Manual	6
Opening the Electronic Manuals	6
Introduction to Functions	8
Measured Items	8
Data Storage Function	8
Display Function	8
Other Functions	8
DAQSTANDARD	8
DX System Configuration	9
Terminology	9
Names of Parts	10
DX2000 Workflow	12
Turning the Power ON/OFF	13
Turning the Power ON	13
Turning the Power OFF	13
Basic Operation	14
Panel Keys and Display	14
Run Modes	16
Entering Values and Characters	17
Changing the Date/Time	18
Operation Example in the Setting Mode: Changing the Input Range	19
Operation Example in the Basic Setting Mode: Changing the Scan Interval	22
Inserting/Removing a CF Card	24
Saving the Setup Data	26
Loading the Setup Data	27
Setting the Input Range and Alarm	28
Setup Example 1: Temperature Measurement Channel	28
Setup Example 2: Flow Rate Measurement Channel and Alarm	29
Setting the Display	30
Setup Example 3: Assigning Channels to Groups	30
Setup Example 4: Setting the Time Scale	31
Setting the Data Storage	32
Setup Example 5: Continuously Record Measured Data and Automatically Save	32
Setup Example 6: Saving Measured Data at the Specified Time	35
Customizing the Operation	36
Setup Example 7: Assigning the Screen Image Data Storage Function to the USER key	36
Setup Example 8: Registering Frequently Used Screens to the Favorite Key	37
Operation	39
Starting the Memory Sample	39
Stopping the Memory Sample	39
Switching the Trend Display, Digital Display, and Bar Graph Display	40
Writing the Message "START"	41
Connecting to an Ethernet Network	43
Setup Example 9: Monitoring the DX on a PC Browser	43
Setup Example 10: Automatically Transferring the Measured Data File to an FTP Server	46
Using DAQSTANDARD	48
Displaying the Measured Data on DAQSTANDARD	48

Contents

Installation and Wiring	49
Installation Location	49
Installation Procedure	50
△ Input Signal Wiring	52
△ Optional Terminal Wiring	55
Alarm Output Terminal, FAIL Output Terminal, and Status Output Terminal (/A1, /A2, /A3, /A4, /A5, /F1, and /F2)	57
Remote Control Input Terminal (/R1)	57
Pulse Input Terminal (/PM1)	57
24 VDC Transmitter Power Supply Output Terminal (/TPS4 and /TPS8)	57
Connecting to the RS-232 Connector (/C2)	57
Connecting to the RS-422A/485 (/C3)	58
Connecting to the VGA Connector (/D5)	58
Connecting to the USB Port (/USB1)	59
Connecting to the Ethernet Port	59
△ Power Supply Wiring	60
Recommended Replacement Periods for Worn Parts Maintenance	62
Setup Items and Default Values	63
Setup Items in Setting Mode and Their Default Values	64
Setup Items in Basic Setting Mode and Their Default Values	73

Daqstation DX2000 User's Manual (Electronic Manual Provided on the Accompanying CD)

Chapter 1	Overview of Functions
Chapter 2	Common Operations
Chapter 3	Measurement Channels and Alarms
Chapter 4	Switching Operation Screens
Chapter 5	Operations for Changing the Displayed Contents
Chapter 6	Saving and Loading Data
Chapter 7	Customizing the Operation (Event Action)
Chapter 8	Security Function
Chapter 9	Computation and Report Functions (/M1 and /PM1 Options)
Chapter 10	External Input Channels (/MC1 Option)
Chapter 11	Troubleshooting
Chapter 12	Maintenance
Chapter 13	Specifications

Daqstation DX1000/DX1000N/DX2000 Communication Interface User's Manual (Electronic Manual Provided on the Accompanying CD)

Chapter 1	Using the Ethernet Interface
Chapter 2	Using the Serial Interface
Chapter 3	Commands
Chapter 4	Responses
Chapter 5	Status Reports
Chapter 6	Specifications

Foreword

Thank you for purchasing the Daqstation DX2000 (DX). This manual describes the basic functions and operating procedures of the DX2000. To ensure correct use, please read this manual thoroughly before operation. The following four manuals are provided as DX2000 manuals.

Paper Manual

Manual Title	Manual No.
DX2000 Operation Guide	IM 04L42B01-02E
This manual. It is also provided in the CD.	

Electronic Manuals Provided on the Accompanying CD

Manual Title	Manual No.
DX2000 Operation Guide	IM 04L42B01-02E
This is the electronic version of the paper manual.	
DX2000 User's Manual	IM 04L42B01-01E
Describes how to use the convenient functions of the DX2000. Communication function is excluded.	
DX1000/DX1000N/DX2000 Communication Interface User's Manual	IM 04L41B01-17E
Describes how to use the communication functions using the Ethernet and serial interfaces.	
DAQSTANDARD User's Manual	IM 04L41B01-61E
Describes how to use the accompanying software program, DAQSTANDARD.	

Notes

- The contents of this manual are subject to change without prior notice as a result of continuing improvements to the instrument's performance and functions.
- Every effort has been made in the preparation of this manual to ensure the accuracy of its contents. However, should you have any questions or find any errors, please contact your nearest YOKOGAWA dealer.
- Copying or reproducing all or any part of the contents of this manual without YOKOGAWA's permission is strictly prohibited.
- The TCP/IP software of this product and the document concerning the TCP/IP software have been developed/created by YOKOGAWA based on the BSD Networking Software, Release 1 that has been licensed from the Regents of the University of California.

Trademarks

- All the brands or names of Yokogawa Electric's products used in this manual are either trademarks or registered trademarks of Yokogawa Electric Corporation.
- Microsoft, MS-DOS, Windows, Windows NT, and Windows XP are either registered trademarks or trademarks of Microsoft Corporation in the United States and/or other countries.
- Adobe, Acrobat, and PostScript are trademarks of Adobe Systems Incorporated (Adobe Systems).
- CompactFlash and CF are trademarks of SanDisk Corporation.
- For purposes of this manual, the TM and ® symbols do not accompany their respective trademark names or registered trademark names.
- Company and product names that appear in this manual are trademarks or registered trademarks of their respective holders.

Revisions

1st Edition: December 2005

1st Edition: December 2005 (YK)
All Right Reserved, Copyright © 2005, Yokogawa Electric Corporation

Safety Precautions

The DX conforms to IEC safety class I (provided with terminal for protective grounding), Installation Category II, and EN61326-1 (EMC standard), class A (use in a commercial, industrial, or business environment).

The DX is a measurement category II (CAT II) instrument.

* Measurement category II (CAT II)

Applies to measuring circuits connected to low voltage installation, and electrical instruments supplied with power from fixed equipment such as electric switchboards.

The general safety precautions described here must be observed during all phases of operation. If the DX is used in a manner not described in this manual, the protection provided by the DX may be impaired. Yokogawa Electric Corporation assumes no liability for the customer's failure to comply with these requirements.

Use the DX as a measurement category II (CAT II) instrument.

The DX is designed for indoor use.

About This Manual

- Please pass this manual to the end user. We also ask you to store this manual in a safe place.
- Read this manual thoroughly and have a clear understanding of the product before operation.
- This manual explains the functions of the product. It does not guarantee that the product will suit a particular purpose of the user.

Precautions Related to the Protection, Safety, and Alteration of the Product

The following safety symbols are used on the product and in this manual.



"Handle with care." To avoid injury and damage to the instrument, the operator must refer to the explanation in the manual.



Protective ground terminal



Functional ground terminal (do not use this terminal as a protective ground terminal.)



Alternating current



ON (power)



OFF (power)

- For the protection and safe use of the product and the system in which this product is incorporated, be sure to follow the instructions and precautions on safety that are stated in this manual whenever you handle the product. Take special note that if you handle the product in a manner that violates these instructions, the protection functionality of the product may be damaged or impaired. In such cases, YOKOGAWA does not guarantee the quality, performance, function, and safety of product.
- When installing protection and/or safety circuits such as lightning protection devices and equipment for the product and control system or designing or installing separate protection and/or safety circuits for fool-proof design and fail-safe design of the processes and lines that use the product and the control system, the user should implement these using additional devices and equipment.
- If you are replacing parts or consumable items of the product, make sure to use parts specified by YOKOGAWA.
- This product is not designed or manufactured to be used in critical applications that directly affect or threaten human lives. Such applications include nuclear power equipment, devices using radioactivity, railway facilities, aviation equipment, air navigation facilities, aviation facilities, and medical equipment. If so used, it is the user's responsibility to include in the system additional equipment and devices that ensure personnel safety.
- Do not modify this product.

WARNING

- **Use the Correct Power Supply**
Ensure that the source voltage matches the voltage of the power supply before turning ON the power. In the case of a desktop type, ensure that it is within the maximum rated voltage range of the provided power cord before connecting the power cord.
- **Use the Correct Power Cord and Plug (Desktop Type)**
To prevent electric shock or fire, be sure to use the power cord supplied by YOKOGAWA. The main power plug must be plugged into an outlet with a protective earth terminal. Do not disable this protection by using an extension cord without protective earth grounding.
- **Connect the Protective Grounding Terminal**
Make sure to connect the protective grounding to prevent electric shock before turning ON the power.
The power cord that comes with the desktop type is a three-prong type power cord. Connect the power cord to a properly grounded three-prong outlet.
- **Do Not Impair the Protective Grounding**
Never cut off the internal or external protective grounding wire or disconnect the wiring of the protective grounding terminal. Doing so invalidates the protective functions of the instrument and poses a potential shock hazard.
- **Do Not Operate with Defective Protective Grounding**
Do not operate the instrument if the protective grounding might be defective. Also, make sure to check them before operation.
- **Do Not Operate in an Explosive Atmosphere**
Do not operate the instrument in the presence of flammable liquids or vapors. Operation in such an environment constitutes a safety hazard.
Prolonged use in a highly dense corrosive gas (H₂S, SO_x, etc.) will cause a malfunction.
- **Do Not Remove Covers**
The cover should be removed by YOKOGAWA's qualified personnel only. Opening the cover is dangerous, because some areas inside the instrument have high voltages.
- **Ground the Instrument before Making External Connections**
Connect the protective grounding before connecting to the item under measurement or control unit.
- **Damage to the Protection**
Operating the instrument in a manner not described in this manual may damage the instrument's protection.

- **Exemption from Responsibility**
 - YOKOGAWA makes no warranties regarding the product except those stated in the WARRANTY that is provided separately.
 - YOKOGAWA assumes no liability to any party for any loss or damage, direct or indirect, caused by the user or any unpredictable defect of the product.
- **Handling Precautions of the Software**
 - YOKOGAWA makes no warranties regarding the software accompanying this product except those stated in the WARRANTY that is provided separately.
 - Use the software on a single PC.
 - You must purchase another copy of the software, if you are to use the software on another PC.
 - Copying the software for any purposes other than backup is strictly prohibited.
 - Please store the original media containing the software in a safe place.
 - Reverse engineering, such as decompiling of the software, is strictly prohibited.
 - No portion of the software supplied by YOKOGAWA may be transferred, exchanged, or sublet or leased for use by any third party without prior permission by YOKOGAWA.

Handling Precautions of the DX

- Use care when cleaning the DX, especially any plastic parts. When cleaning, wipe using a dry soft cloth. Do not use chemicals such as benzene or thinner, since these may cause discoloring and deformation.
- Keep electrically charged objects away from the signal terminals. If you do, the DX may malfunction.
- Do not apply volatile chemicals to the display, panel keys, etc. Do not allow rubber and vinyl products to remain in contact with the DX for long periods of time. If you do, the DX may malfunction.
- When not in use, make sure to turn OFF the power switch.
- If there are any symptoms of trouble such as strange odors or smoke coming from the DX, immediately turn OFF the power switch and the power supply source. Then, contact your nearest YOKOGAWA dealer.

Handling Precautions of the External Storage Medium (CF Card)

- Use caution in the handling of the external storage medium as it is a delicate product.
- Write operation to storage media may fail under high-temperature or low-temperature environments. If you are using the DX in a low-temperature environment (around 10 °C or less), use the DX after the warm-up time (at least 30 minutes) has elapsed. If you are using the DX under a high-temperature environment (around 40 °C or more), it is recommended that the external storage medium be inserted into the drive when saving the data and be removed after the data storage operation is finished.
- Remove the storage medium from the drive when turning the DX ON/OFF.
- Touching the compact flash section when static electricity is built up on the human body can lead to erroneous operation.
- For the general handling precautions of the external storage medium, see the instruction manual that came with the external storage medium.

CAUTION

- Do not eject the external storage medium while the access indicator is illuminated. This can damage the data.
 - Do not access the storage medium in a place with vibrations or shock. The storage medium or drive may malfunction.
-

Checking the Contents of the Package

Unpack the box and check the contents before operating the instrument. If some of the contents are not correct or missing or if there is physical damage, contact the dealer from which you purchased them.

DX2000

A name plate is located on the top panel of the DX (side panel on models with the /H5[] option). Check that the model name and suffix code given on the name plate on the rear panel match those on your order.

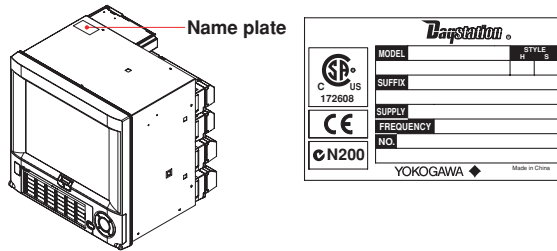

NO. (Instrument Number)

When contacting the dealer from which you purchased the instrument, please give them the instrument number.

MODEL and SUFFIX Code

Model	Suffix Code	Optional Code	Description
DX2004			Daqstation DX2000 4ch, 125 ms (Fast sampling mode 25 ms)
DX2008			Daqstation DX2000 8ch, 125 ms (Fast sampling mode 25 ms)
DX2010			Daqstation DX2000 10ch, 1 s (Fast sampling mode 125 ms)
DX2020			Daqstation DX2000 20ch, 1 s (Fast sampling mode 125 ms)
DX2030			Daqstation DX2000 30ch, 1 s (Fast sampling mode 125 ms)
DX2040			Daqstation DX2000 40ch, 1 s (Fast sampling mode 125 ms)
DX2048			Daqstation DX2000 48ch, 1 s (Fast sampling mode 125 ms)
Internal memory size	-1		Standard memory
memory size	-2		Large memory
External storage media	-4		With CF card
Language		-1	Japanese (Japanese version of DAQSTANDARD included)
		-2	English, deg F, and DST (English version of DAQSTANDARD included)
Options		/A1	Alarm output 2 points ^{*1}
		/A2	Alarm output 4 points ^{*1*11}
		/A3	Alarm output 6 points ^{*1}
		/A4	Alarm output 12 points ^{*1*8*11}
		/A5	Alarm output 24 points ^{*1*2*7*11}
		/C2	RS-232 interface ^{*3}
		/C3	RS-422A/485 interface ^{*3}
		/D5	VGA output
		/F1	FAIL/status output ^{*2*4*8}
		/F2	FAIL + alarm output 22 points ^{*1*4*7*11}
		/H2	Clamped input terminal (detachable)
		/H5[]	Desktop type ^{*5}
		/M1	Mathematical functions (including the report function) ^{*11}
		/N1	Cu10, Cu25 RTD input/3 leg isolated RTD
		/N2	3 leg isolated RTD ^{*6}
		/N3	Extended input type (PR40-20, Pt50, etc.)
		/R1	Remote control ^{*11}
		/TPS4	24-VDC transmitter power supply (4 loops) ^{*7}
		/TPS8	24-VDC transmitter power supply (8 loops) ^{*7*8*11}
		/KB1	Easy Text Entry (with input terminal) ^{*9*10}
		/KB2	Easy Text Entry (without input terminal) ^{*9}
		/USB1	USB interface
		/PM1	Pulse input (including remote control and mathematical function) ^{*11}
		/CC1	Calibration correction function
		/MC1	External input function ^{*12}

^{*1} /A1, /A2, /A3, /A4, /A5, and /F2 cannot be specified simultaneously.

^{*2} /A5 and /F1 cannot be specified simultaneously.

^{*3} /C2 and /C3 cannot be specified simultaneously.

^{*4} /F1 and /F2 cannot be specified simultaneously.

^{*5} /H5[]

D: Power cord UL, CSA st'd

F: Power cord VDE st'd

R: Power cord SAA st'd

J: Power cord BS st'd

H: Power cord GB st'd

^{*6} /N2 can be specified only for DX2010, DX2020, DX2030, DX2040 and DX2048.

^{*7} /TPS4, /TPS8, /A5 and /F2 cannot be specified simultaneously.

^{*8} If /TPS8 is specified, /A4 and /F1 cannot be specified simultaneously.

^{*9} /KB1 and /KB2 cannot be specified simultaneously.

^{*10} If /KB1 is specified, a remote control terminal (438227) is included.

^{*11} If /PM1 is specified, /A5, /F2, /M1, and /R1 cannot be specified simultaneously.

The combination of /A2/F1 and the combination of /A4/TPS8 cannot be specified simultaneously.

^{*12} /MC1 can be specified only for DX2010, DX2020, DX2030, DX2040 and DX2048.

Standard Accessories

The standard accessories below are supplied with the instrument. Check that all contents are present and undamaged.

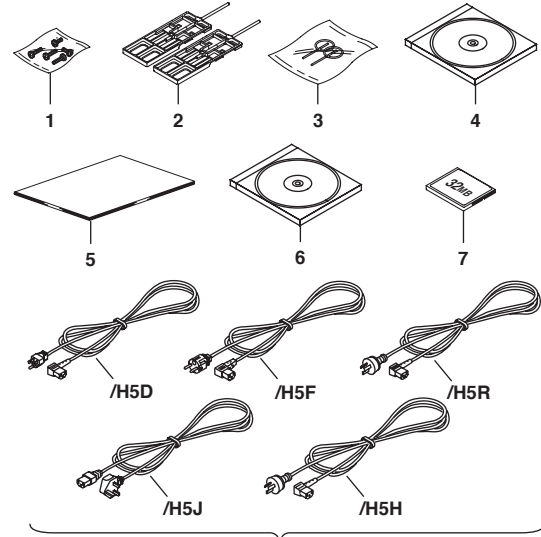

8. One of these power cord types is supplied according to the instrument's suffix code

No.	Name	Part Number/ Model	Qty.	Notes
1	Terminal screws	E9655FX	5	M4 (spares)
2	Mounting brackets	B9900BX	2	For panel mounting Except for the /H5[] models.
3	Door lock key	B8706FX	2	–
4	DAQSTANDARD for DXAdvanced	DXA120	1	CD. Software for setting the DX and displaying data.
5	DX2000 Operation Guide (this manual)	IM 04L42B01-02E	1	A4 size
6	User's Manuals for the DX1000/ DX1000N/DX2000	B8706ZZ	1	CD. Contains the PDF file of the user's manual.
7	CF card	B9968NM	1	32 MB (The size and model may change.)
8	Power cord	A1006WD	1	Supplied only for models with the /H5D option. Maximum rated voltage: 125 V
		A1009WD	1	Supplied only for models with the /H5F option. Maximum rated voltage: 250 V
		A1024WD	1	Supplied only for models with the /H5R option. Maximum rated voltage: 250 V

No.	Name	Number/Model	Qty.	Notes
		A1054WD	1	Supplied only for models with the /H5J option. Maximum rated voltage: 250 V
		A1064WD	1	Supplied only for models with the /H5H option. Maximum rated voltage: 250 V
9	Remote control terminal	438227	1	Remote controller. Supplied only for models with the /KB1 option. With two AA alkaline batteries and labels for the remote control terminal.

Optional Accessories (Sold Separately)

The following optional accessories are available for purchase separately. If you make an order, make sure that all contents are present and undamaged. For information about ordering accessories, contact the dealer from which you purchased the DX.

No.	Name	Model	Minimum Q'ty	Notes
1	CF card	772091	1	128 MB
		772092	1	256 MB
		772093	1	512 MB
		772094	1	1 GB
2	CF card adapter	772090	1	–
3	Shunt resistor (for screw input terminal)	415920	1	250 Ω ± 0.1%
		415921	1	100 Ω ± 0.1%
		415922	1	10 Ω ± 0.1%
4	Shunt resistor (for clamped input terminal)	438920	1	250 Ω ± 0.1%
		438921	1	100 Ω ± 0.1%
		438922	1	10 Ω ± 0.1%
5	Mounting brackets	B9900BX	2	–
6	Door lock key	B8706FX	1	–
7	Remote control terminal	438227	1	Remote controller.

Conventions Used in This Manual

- This manual covers information regarding DX2000s that have a suffix code for language “-2” (English).
- For details on how to set the language, see section 2.6, “Changing the Language” in the *DX2000 User's Manual (IM 04L42B01-01E)*.

Unit

K: Denotes 1024. Example: 768 KB (file size)

k: Denotes 1000.

The following markings are used in this manual.



Improper handling or use can lead to injury to the user or damage to the instrument. This symbol appears on the instrument to indicate that the user must refer to the user's manual for special instructions. The same symbol appears in the corresponding place in the user's manual to identify those instructions. In the manual, the symbol is used in conjunction with the word “WARNING” or “CAUTION.”

WARNING

Calls attention to actions or conditions that could cause serious or fatal injury to the user, and precautions that can be taken to prevent such occurrences.

CAUTION

Calls attentions to actions or conditions that could cause light injury to the user or damage to the instrument or user's data, and precautions that can be taken to prevent such occurrences.

Note

Calls attention to information that is important for proper operation of the instrument.



Indicates after this mark reference to related procedure or explanation.

Bold characters

Indicates character strings that appear on the screen and the operation keys.

Opening the Electronic Manuals

The accompanying CD contains PDF files of the manuals. When you load the CD into the CD-ROM drive on your PC, a startup screen appears. Click the manual title to open the respective manual.

If the startup screen does not appear, double-click DX_manual in My Computer, and open the manuals in the English directory.

Memo

Introduction to Functions

Measured Items

You can connect DC voltage, thermocouple, RTD, and ON/OFF input and measure various values such as temperature and flow rate. The DX samples the input signals at the scan interval to obtain the measured values. The fastest scan interval is 25 ms on the DX2004 and DX2008 and 125 ms on the DX2010, DX2020, DX2030, DX2040, and DX2048. Up to four alarm conditions can be set for each measurement channel.

Data Storage Function

There are two methods of recording measured data. One is to record the measured data continuously, and the other is to record only when certain events occur such as alarms. The measured data is recorded to the internal memory at a specified interval. The data in the internal memory can be stored to a CF card automatically or manually. By connecting to a network via the Ethernet interface, the measured data can also be automatically transferred to an FTP server on a network.

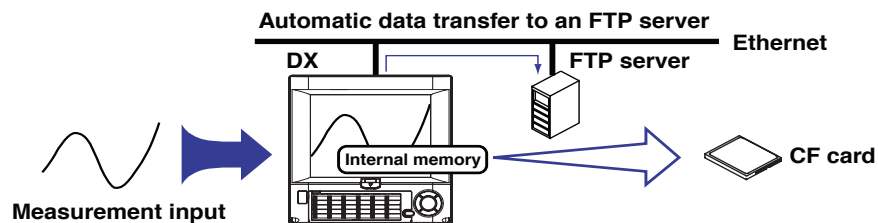

Display Function

Measured data can be displayed as trends, numeric values, and bar graphs for each group. In addition, the overview display can be used to display and monitor all channels on a single screen.

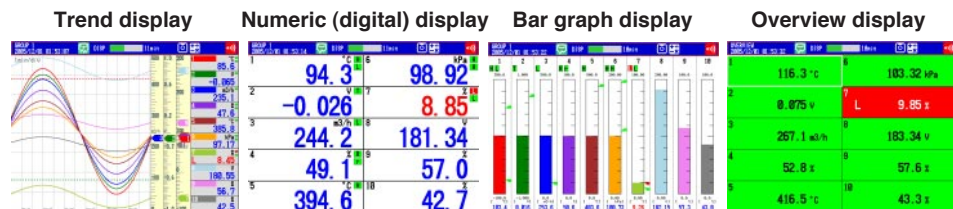

Other Functions

Computation Function (option)	Various types of computation can be performed by assigning equations to computation channels.
FAIL/status output function (option)	Outputs an alarm when the DX fails. The function also monitors the DX status such as the remaining amount of internal memory and outputs alarms.
Remote control function (option)	A specified action is executed when a remote input signal is applied to the terminal on the rear panel.
Security function	Enables only registered users can operate the DX. The function can also be used to prohibit key operation.
Communication function	The Ethernet interface can be used to monitor the DX using a Web browser and transmit e-mail when an event occurs such as an alarm. In addition, data of devices on the network can be loaded and displayed using the Modbus protocol.

DAQSTANDARD

The accompanying software program, DAQSTANDARD, can be used to display the measured data, convert the measured data format, and create DX setup data.

DX System Configuration

The DX can be used to configure a system as shown below.
 Referenced sections are of the *DX2000 User's Manual*.
 Referenced pages are of this manual.

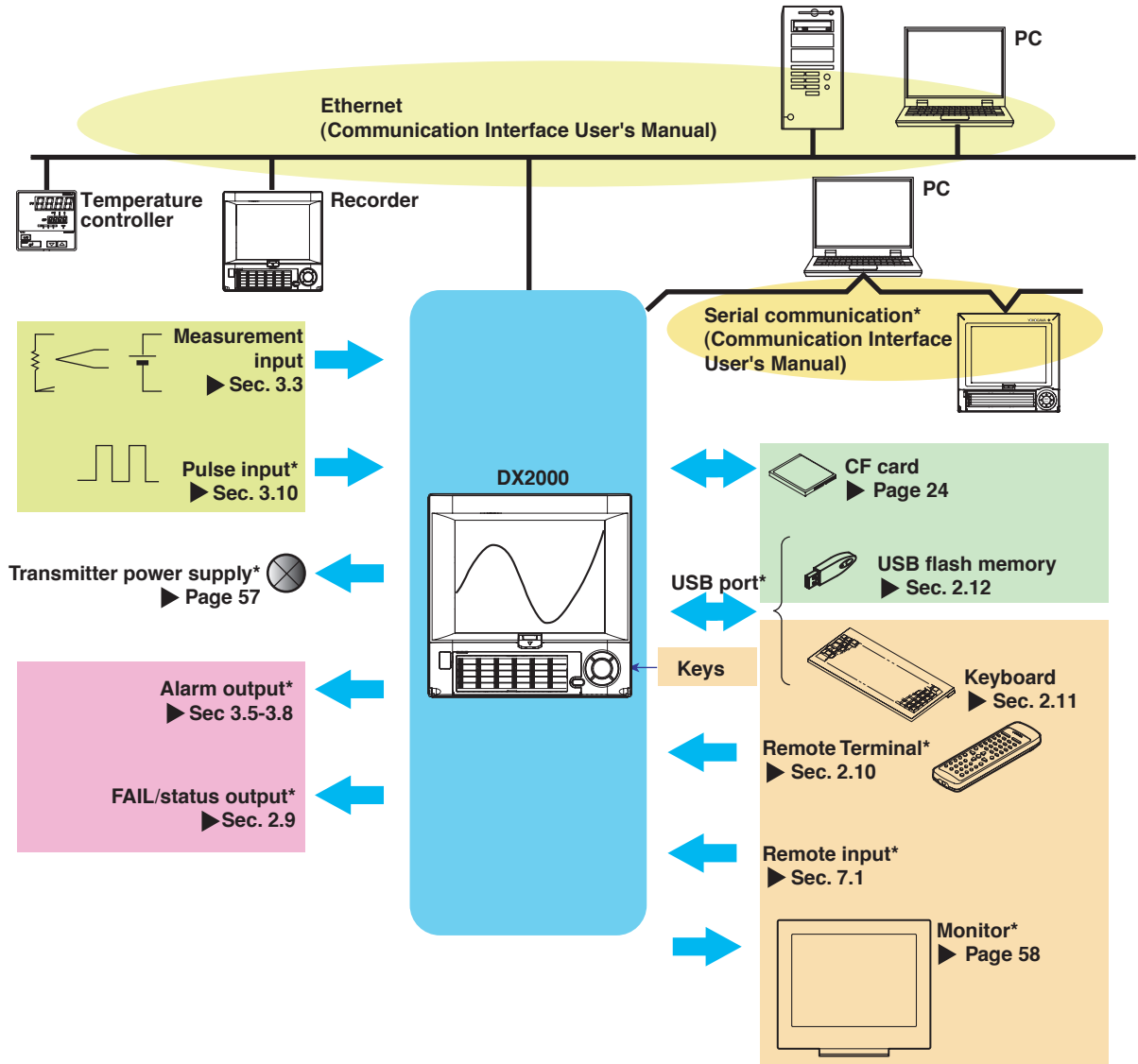

*: Option

Terminology

- **Memory sample**
The operation of recording measured data.
- **Memory start**
The operation of starting the memory sample.
- **Memory stop**
The operation of stopping the memory sample.
- **Display data**
The waveform data shown on the DX display. The data recorded at the sampling interval for the displayed data.
- **Event data**
Measured data recorded at a sampling interval separate from that of the display data.

Names of Parts

Front View

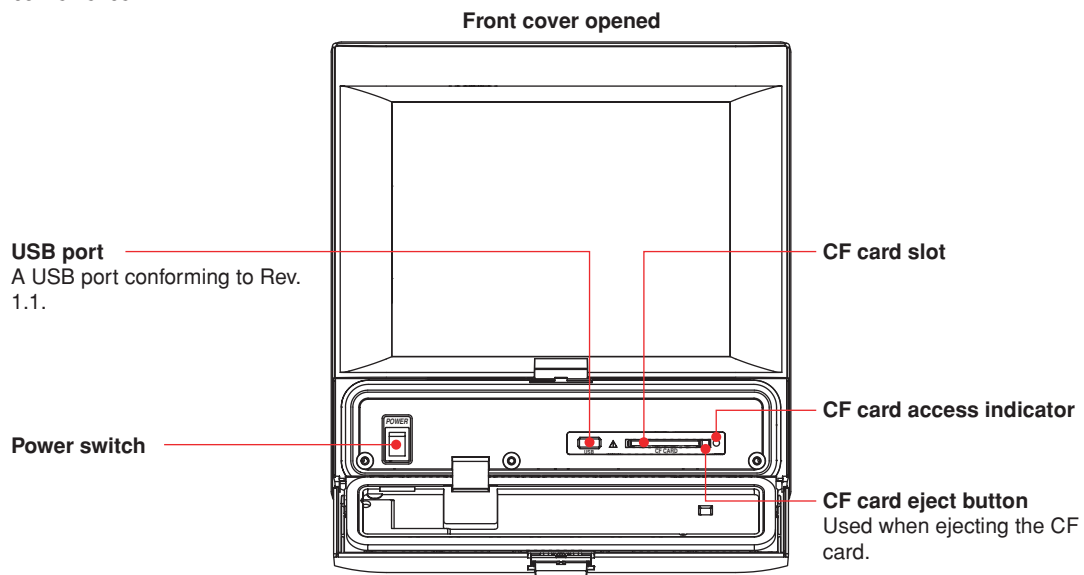
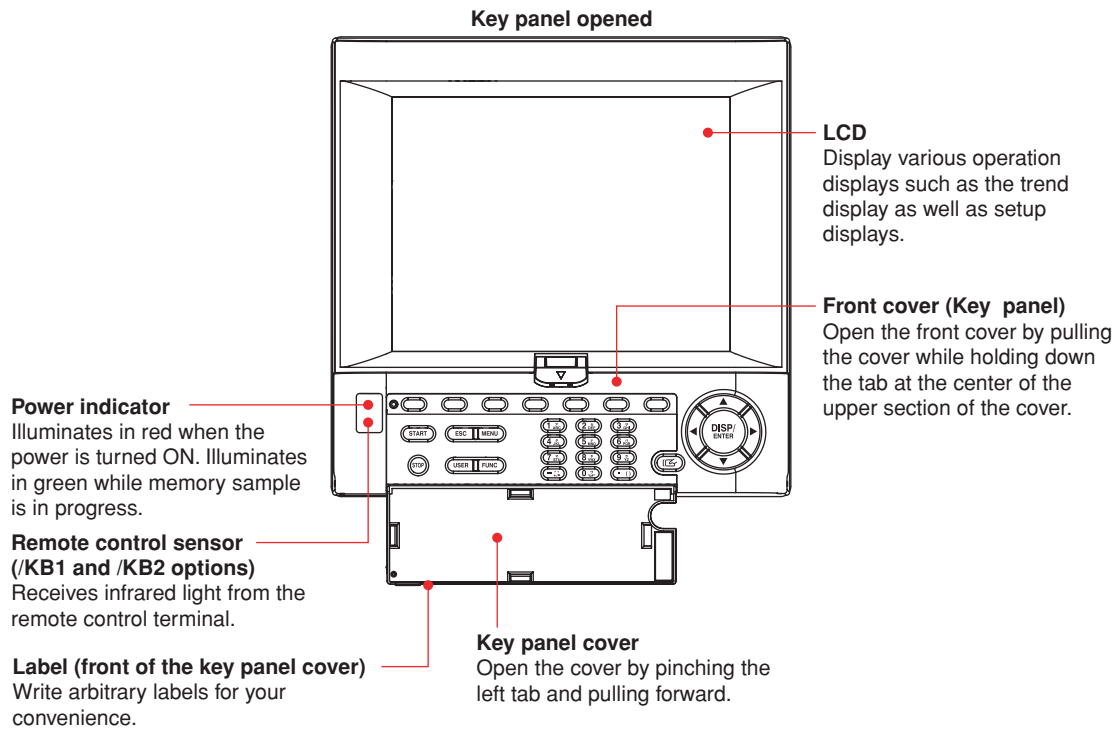

Door lock key (included)
Insert the pin in the left hold to lock.
Insert the pin in the left hold to unlock.

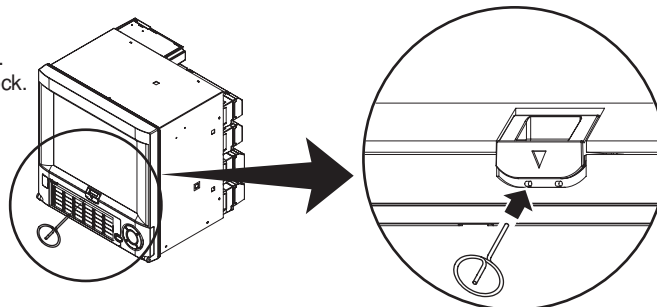

Rear Panel

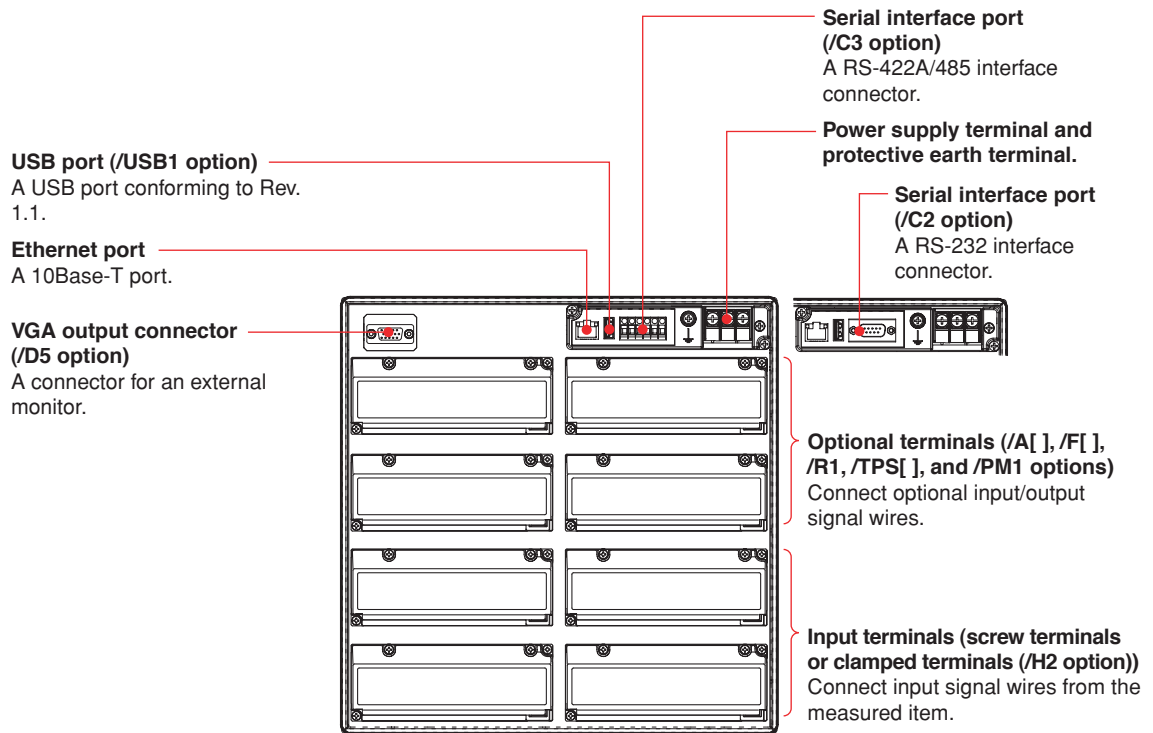

Desktop Type (/H5[] Option)

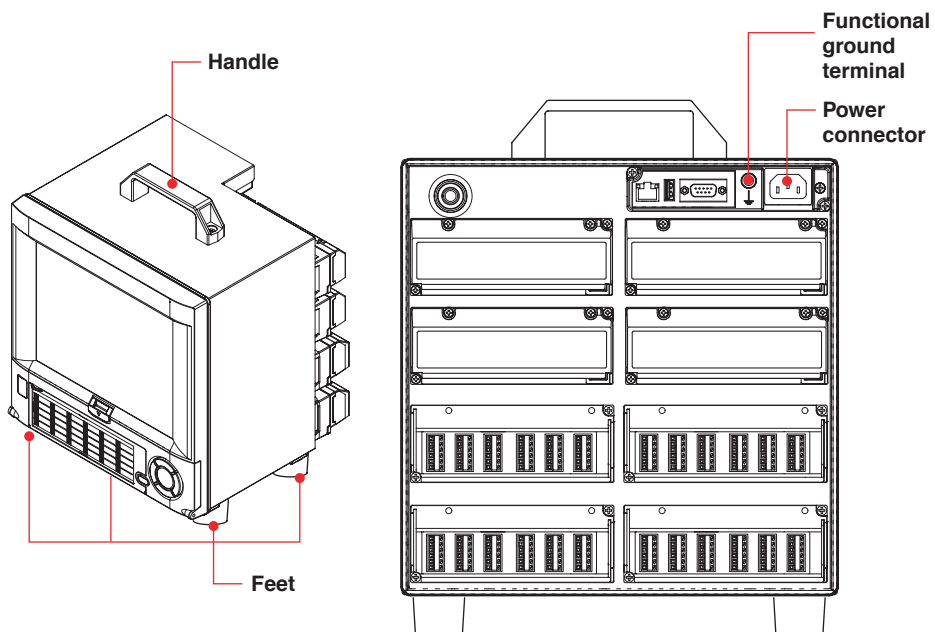

DX2000 Workflow

When using the DX for the first time, carry out the following procedure.

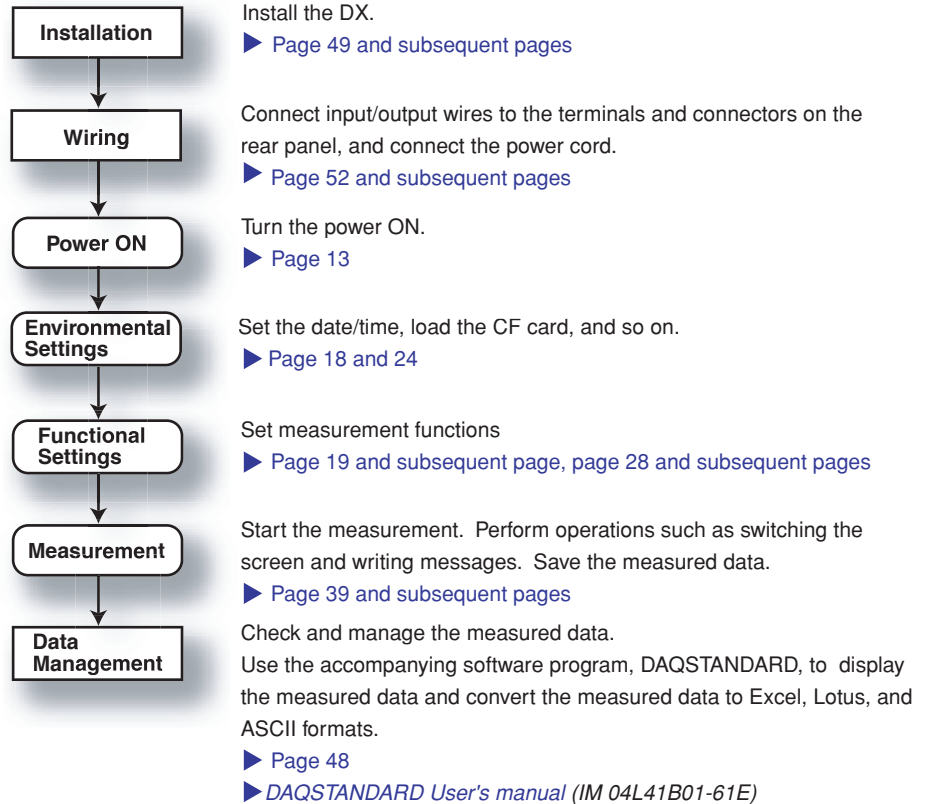

Turning the Power ON/OFF

Turning the Power ON



CAUTION

Before turning ON the power switch, check that

- The power cord/wires are connected correctly to the DX.
- The DX is connected to the correct power supply (see page 60).

If the input wires are connected in parallel with other devices, do not turn ON/OFF the power switch of the DX or another device during operation. This can have adverse effects on the measured values.

1. Open the operation cover.
2. Turn ON the power switch.

After performing a self-test for a few seconds, the operation screen appears.

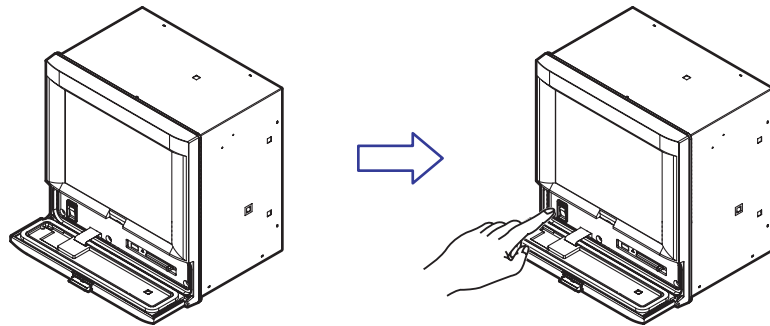

3. Close the operation cover.



CAUTION

- If nothing is displayed when the power switch is turned ON, turn OFF the power switch and check the points listed above one more time. After checking the points, turn ON the power switch again. If the DX still does not work, it is probably a malfunction. Contact your nearest YOKOGAWA dealer for repairs.
- If an error message is displayed on the screen, take measures according to the description in chapter 11, "Troubleshooting" in the *DX2000 User's Manual*.
- Turn ON the power switch, let the DX warm up for at least 30 minutes, and then start the measurements.

Turning the Power OFF



CAUTION

Before turning OFF the power switch, check that the external storage medium is not being accessed.

1. Open the operation cover.
2. Turn OFF the power switch.
3. Close the operation cover.

Basic Operation

Panel Keys and Display Keys

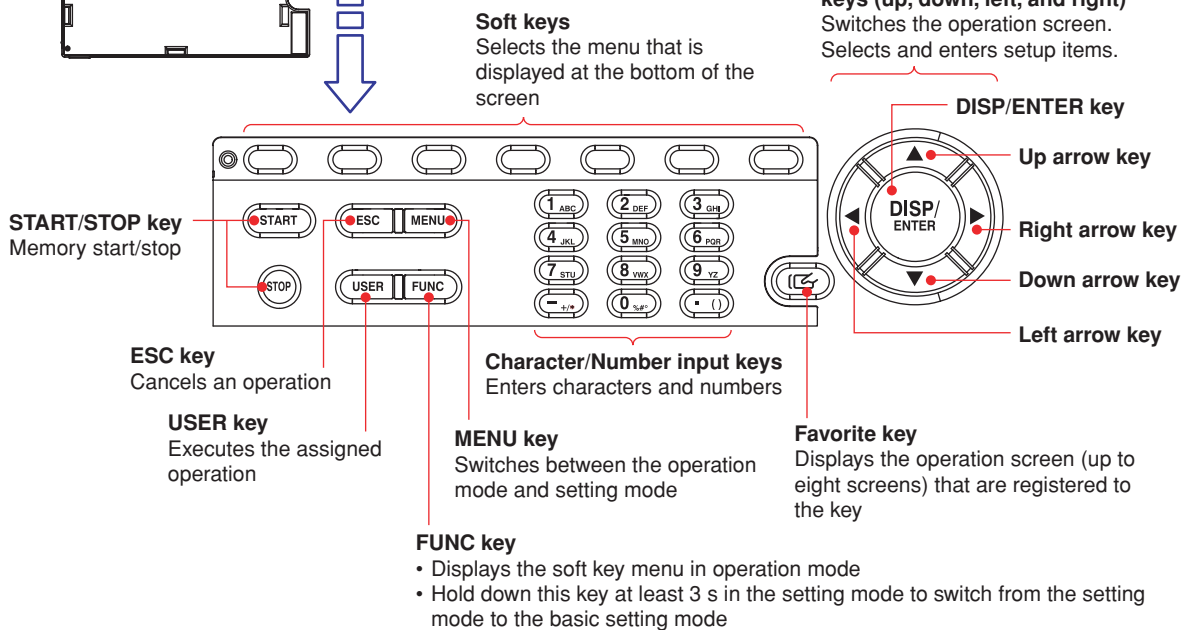
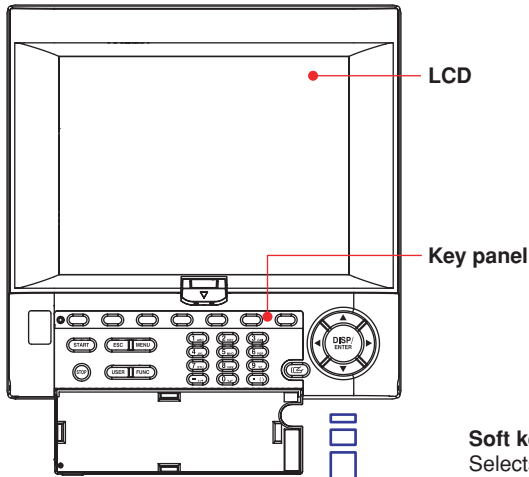

Display

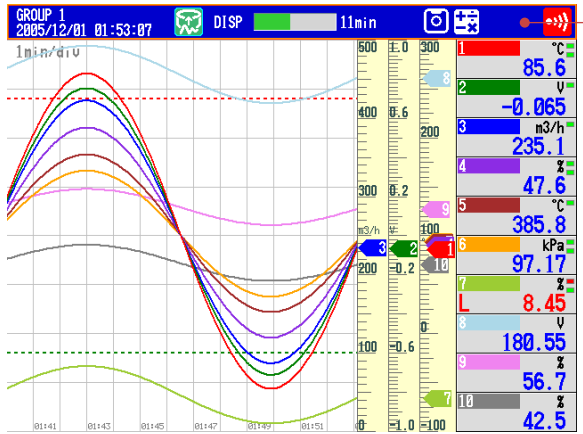

Status display section

Shows the display name, date/time, data recording, alarm icon, etc.

Data display section

Shows the measured data and the functional setup display.

Display on the Status Display Section

The following information is displayed in the status display section.

Memory sample status

Data type
DISP: Display data
EVENT: Event data

Memory sample stopped

Memory sample in progress

Memory sample icon

Memory sample progress
Displays the progress using a green bar graph. The frame indicates the file save interval (display data) or the data length (event data).

Error in internal memory.

Displays the remaining memory sample time for the left bar graph.



Display name or group name
For all channel display on the trend display, "ALL" is displayed.

Date and time
Displayed in yellow while the time is being corrected.

When using the batch function
P1-process-000003
2005/09/22 10:57:47
Batch name (shown alternately with the display name)
Date and time

If the "batch number-lot number" exceeds 20 characters, the "date and time" position is used to display the "batch number-lot number."

When using the login function
Admin1
GROUP 1
2005/09/22 11:03:40
Name of the user logged in
Display name
Date and time

When using the login and batch functions
Admin1
P1-process-000004
2005/09/22 11:03:47
Name of the user logged in
Batch name (shown alternately with the display name)
Date and time

Alarm icon
 (Red) Displayed when any alarm is activated. Blinks when there are alarms that are occurring but have not been acknowledged.
 (Green) All alarms have been released after they have occurred, but there are alarms that have not been acknowledged.

Status icon
 The status assigned to the status output relay (/F1 option) is occurring.

Keys are locked.

E-mail transmission is enabled.

Computation icon (/M1 option)
 White icon: Computation in progress
 Yellow icon: Computation dropout occurred

CF card icon
 CF card is being accessed.
 Waiting.
 CF card error.

The green level display indicates the amount of CF card used. If the remaining amount falls to 10% or less of the CF card capacity, the color changes to red.

Run Modes

Mode Transition Diagram

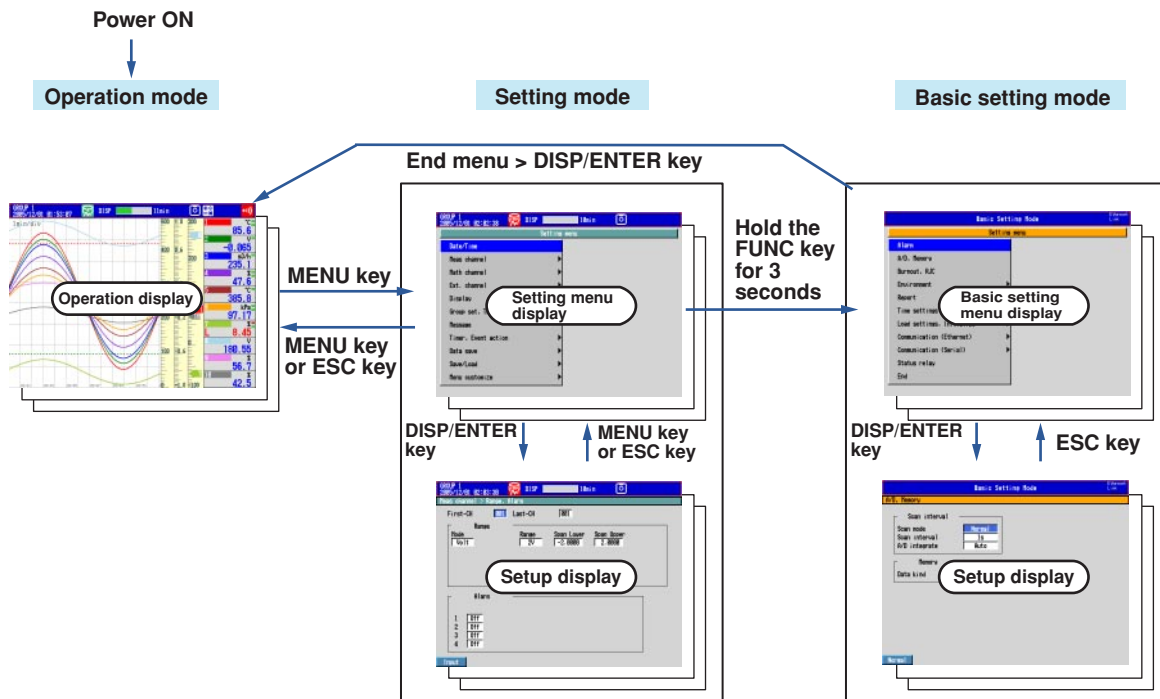

The DX has three modes.

Mode	Description
Operation mode	A mode for performing measurements.
Setting mode	A mode in which input range, measurement method, and so on are configured. Settings can be changed when memory sample is in progress excluding some items.
Basic setting mode	A mode used to set basic items such as the scan interval and storage format of measured data. You cannot switch to this mode when memory sample is in progress.

* For further details on the basic setting mode and setting mode, see page 63.

Carry out the steps given in the following pages. It will help you to understand the DX operation.

Entering Values and Characters

The character/number input keys and DISP/ENTER key are used to set the date/time, set the display span of the input range, set the tag, set the message string, enter the password, etc.

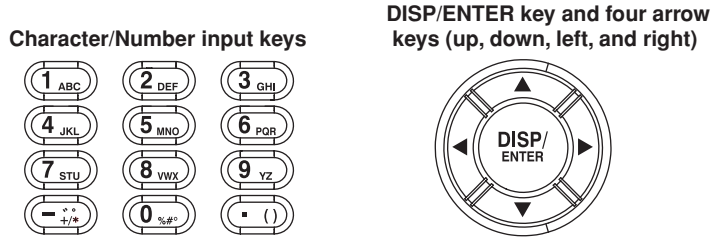

Entering Values

When a window for entering a value appears, enter the value by performing the following key operation.

- **Left and right arrow keys:** Selects the input position.
- **Character/Number input keys:** Enters a value.

The following soft key appears when it can be used.



- **Space soft key:** Enters a space.

Entering Character Strings

When a window for entering a character string appears, enter it by performing the following key operation.

- **Left and right arrow keys:** Selects the input position.
- **Character/Number input keys:** Enters a character string.

The character to be entered is determined by the number of times the character type key and the character/number input key is pressed. The character types that can be entered vary depending on the item being set.



Input status of the A/a/1 soft key

Input status of the Ins soft key

- **Space soft key:** Enters a space.
- **Del soft key:** Deletes the character at the cursor.
- **Bs soft key:** Deletes the character before the cursor.
- **Ins soft key:** Selects insert or overwrite.
Insert and overwrite mode toggles each time the Ins soft key is pressed. The selected mode is shown on the right side of the soft key display section.
- **A/a/1 soft key:** Selects uppercase alphabet (A), lowercase alphabet (a), or value (1).
The character type that you can enter changes each time you press the A/a/1 soft key. The selected character type is shown on the right side of the soft key display section.

Changing the Date/Time

In this example, we will change the date to the 14th. After carrying out this step, reset the time to the correct date/time.

1. Display the operation mode screen.

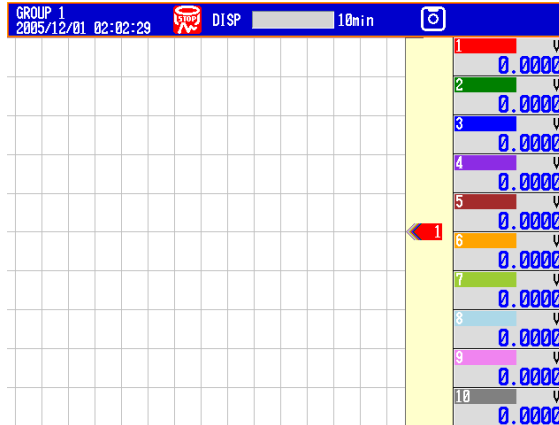

2. Press **MENU** once to display the setting menu.

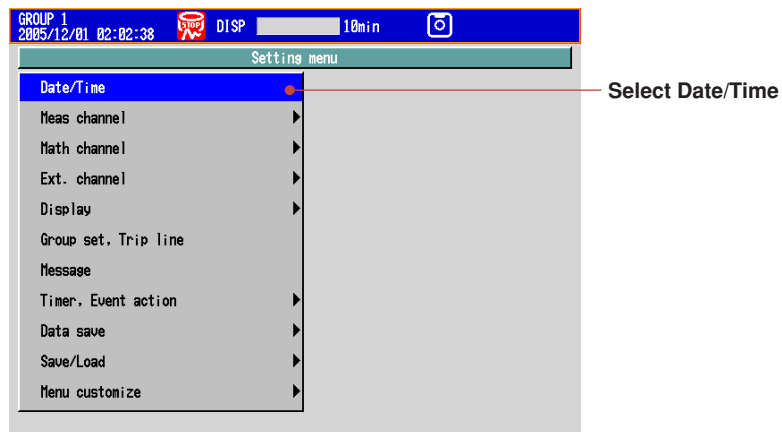

3. Press **DISP/ENTER** once to open the Time set window.
4. Set the date to 14.

Select the input position: **Left and right arrow keys**

Change the value: **Character/Number input keys**

Enter the input: **DISP/ENTER**

Cancel the setting: Press **ESC** before pressing **DISP/ENTER**.

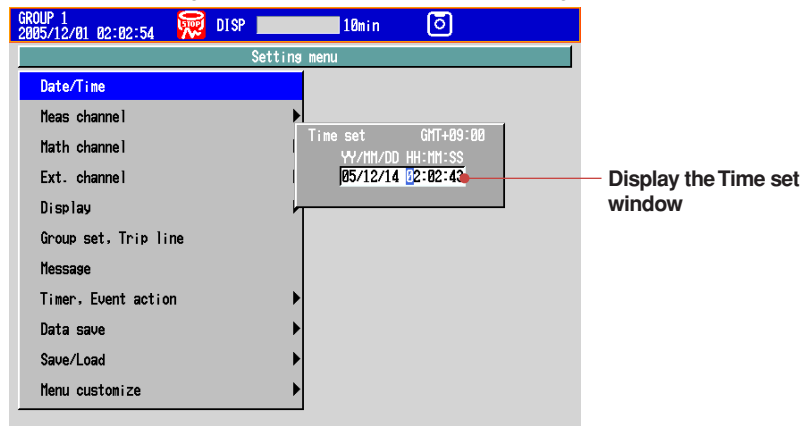

5. Press **ESC** or **MENU** once to return to the operation mode screen.

Operation complete.

Operation Example in the Setting Mode: Changing the Input Range

Set the input range of channel 2 to thermocouple type T and 0.0 to 400.0°C.

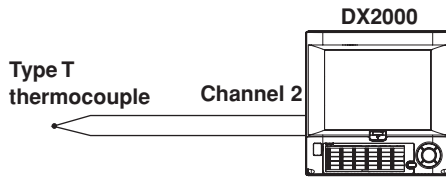

1. Display the operation mode screen.

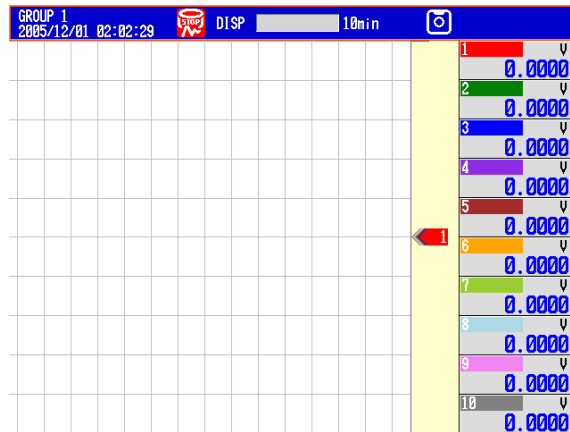

2. Press **MENU** once to display the setting menu.
3. Press the **down arrow key** once to select **Meas. Channel**.
4. Press the **right arrow key** once.

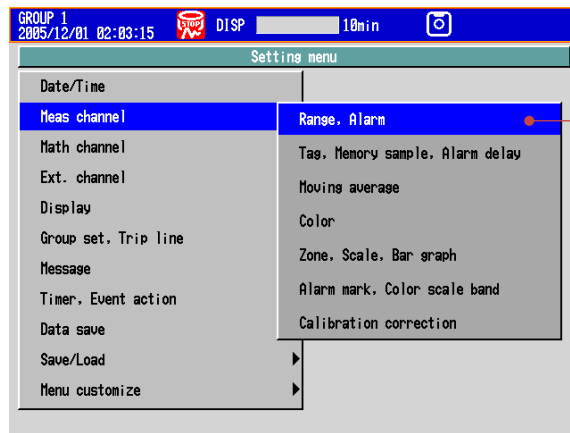

5. Press **DISP/ENTER** once.

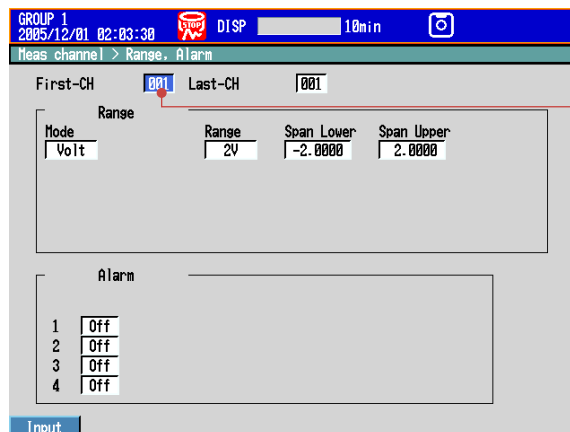

6. Press the **Input** soft key once.

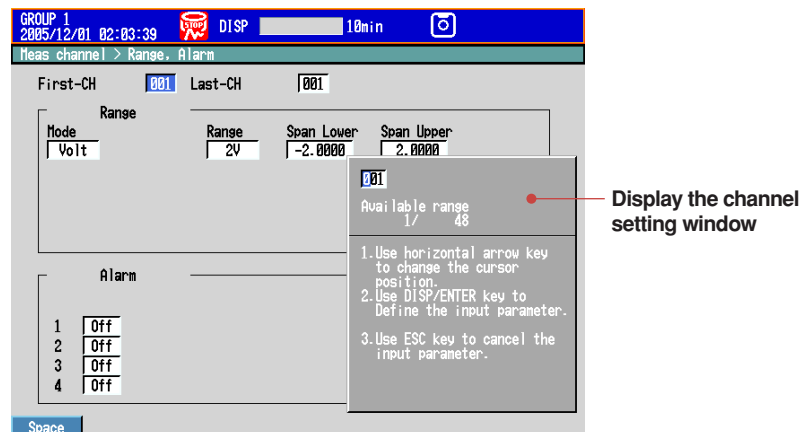

7. Enter 002.
 Select the digit: **Left and right arrow keys**
 Change the value: **Character/Number input keys**
 Delete the value: **Space soft key**
 Cancel the setting: Press **ESC** before pressing **DISP/ENTER**.
8. Press **DISP/ENTER** once. The last channel is also set to 002.
9. Press the **down arrow key** once to move the cursor to **Mode**.
10. Press the **TC** soft key once. The cursor moves to **Range**, and the changed item is displayed in yellow.

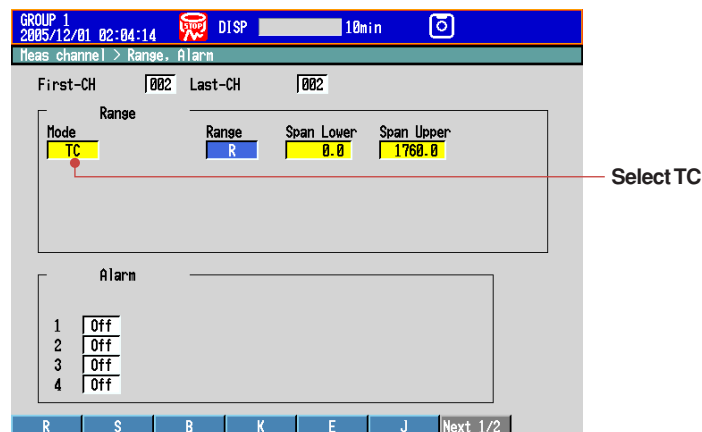

11. Press the **Next** soft key.
12. Press the **T** soft key once. The cursor moves to **Span Lower**.
13. Press the **Input** soft key once.

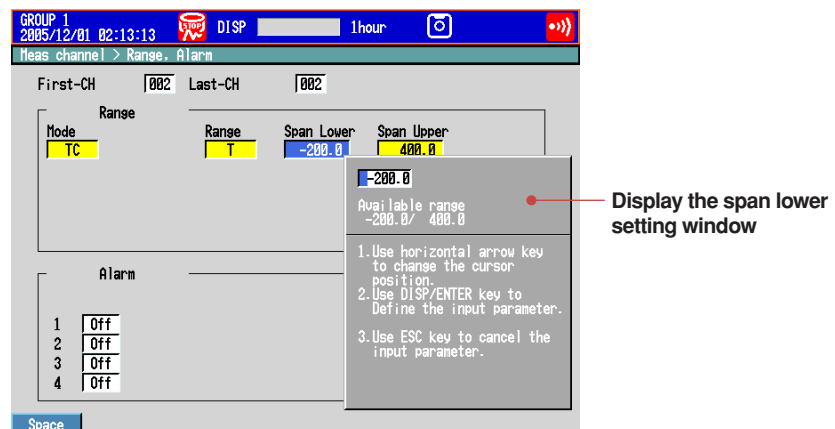

14. Enter 0.0 in the Span Lower box.
See step 7 for the procedure.
15. Press **DISP/ENTER** once. The cursor moves to **Span Upper**.
16. Enter 400.0 in the Span Upper box.
See step 7 for the procedure.
17. Press **DISP/ENTER** once. The changed items are entered, and the cursor returns to First-CH. The changed items change from yellow to white.

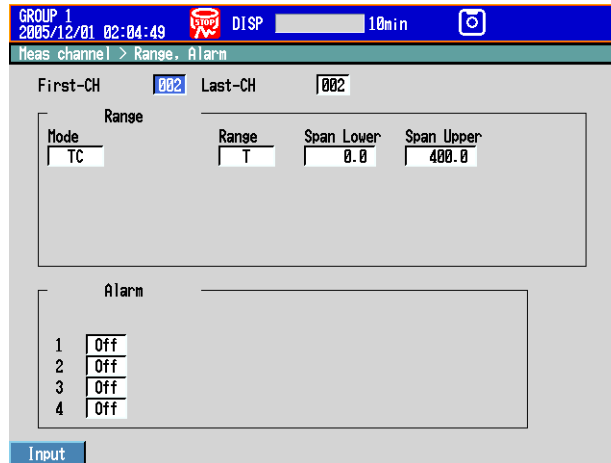

18. Press **ESC** or **MENU** three times to return to the operation mode screen.

Operation complete.

Operation Example in the Basic Setting Mode: Changing the Scan Interval

In this example, we will change the scan interval. Here, the scan interval on the DX2010 is changed to 2 s. The selectable scan intervals are different on the DX2004 and DX2008, but the procedure is the same.

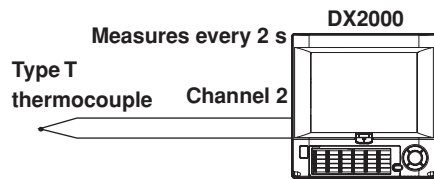

1. Display the operation mode screen.

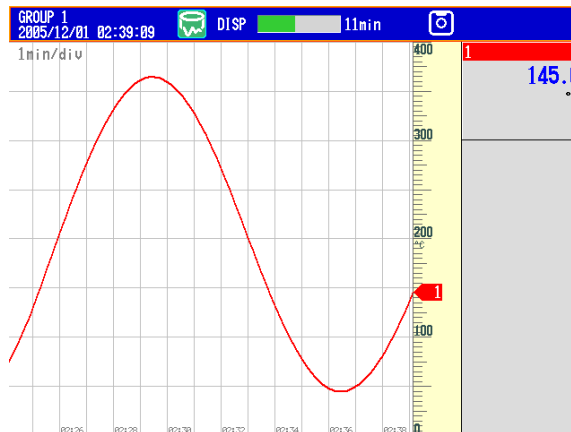

2. Press **MENU** once to display the setting menu.

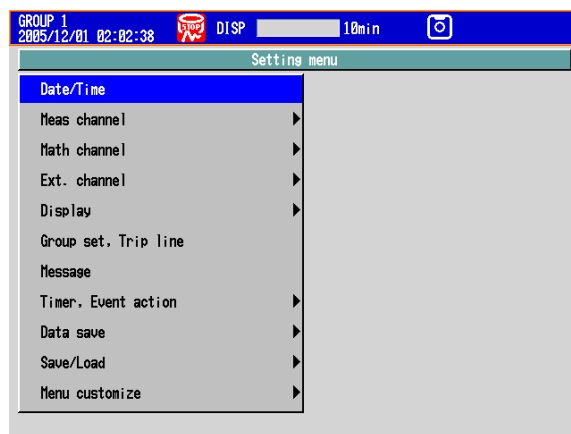

3. Hold down **FUNC** for at least 3 s.

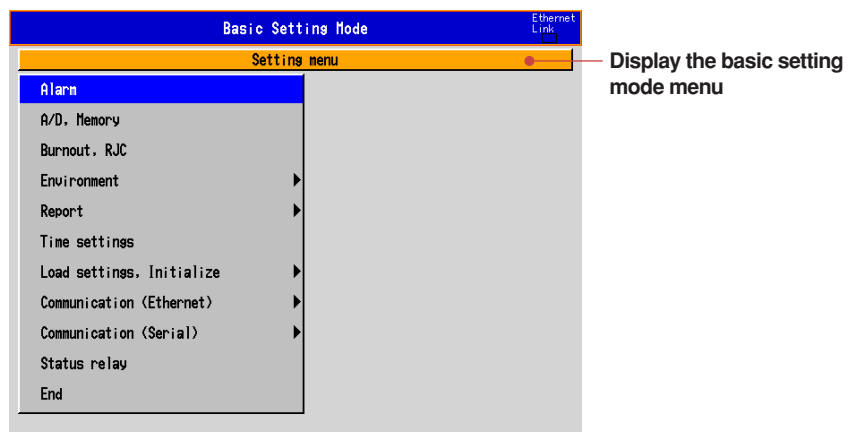

4. Press the **down arrow key** once to select **A/D, Memory**.

5. Press **DISP/ENTER** once.

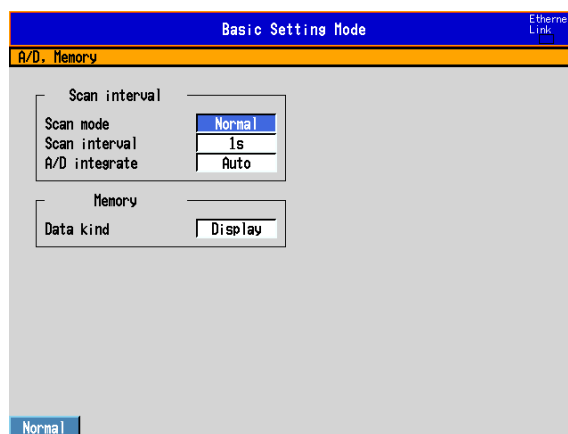

6. Press the **down arrow key** once to move the cursor to **Scan interval**.
7. Press the **2s** soft key once. The cursor moves to **A/D integrate**, and the changed item is displayed in yellow.
Cancel the setting: Press **ESC** before pressing **DISP/ENTER**.
8. Press **DISP/ENTER** once. The changed items are entered, and the cursor returns to **Scan mode**.

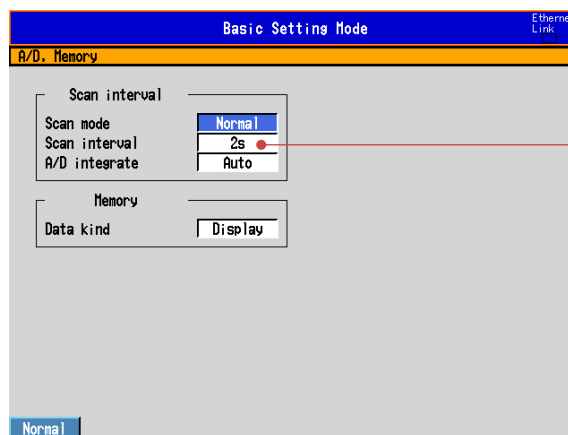

Set the scan interval to 2 s

9. Press **ESC** once to return to the basic setting mode menu.
10. Press the **up arrow key** twice to move the cursor to **End**.
11. Press **DISP/ENTER** once.

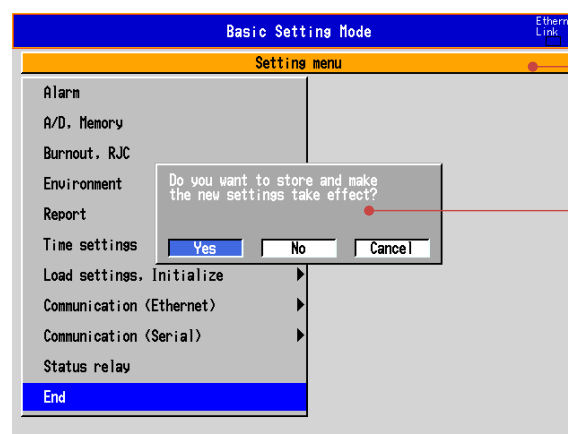

Display the basic setting mode menu

Display the confirmation window

12. Press **DISP/ENTER** once. The settings are saved, and the DX returns to the operation mode screen.
Discard the changes: Select **No** and press **DISP/ENTER**.
Do not end the basic setting mode: Select **Cancel** and press **DISP/ENTER**.

Operation complete.

Inserting/Removing a CF Card

Inserting a CF Card

1. Open the operation cover.

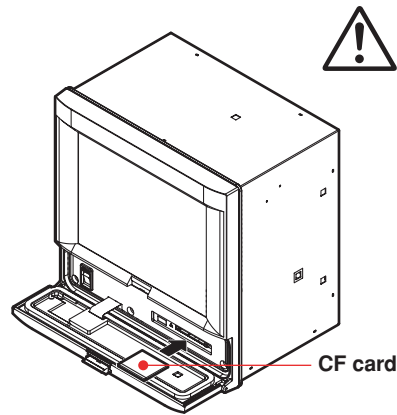

CAUTION

Forcing the CF card into the slot with the upside down may cause damage.

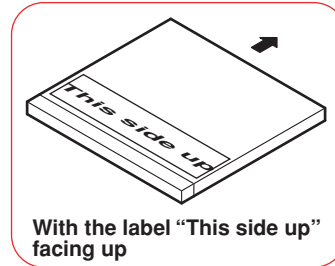

2. Insert the CF card into the slot.

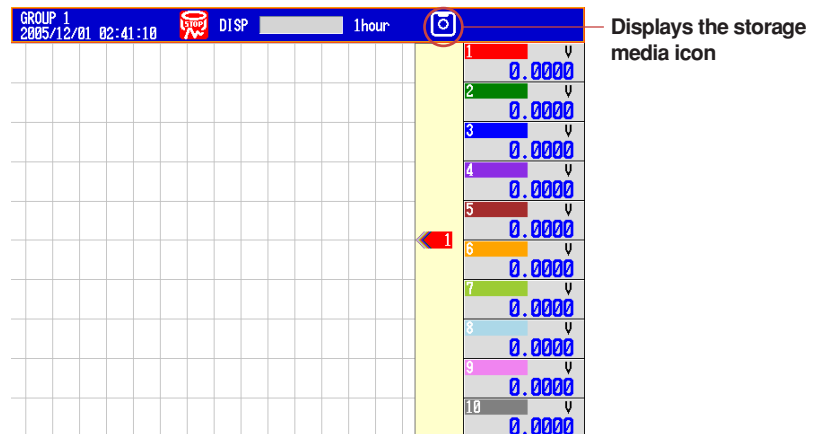

3. Close the operation cover.

Operation complete.

Removing a CF Card

<Operations in the Operation Mode>

1. Press **FUNC** once.
2. Press the **Next** soft key.

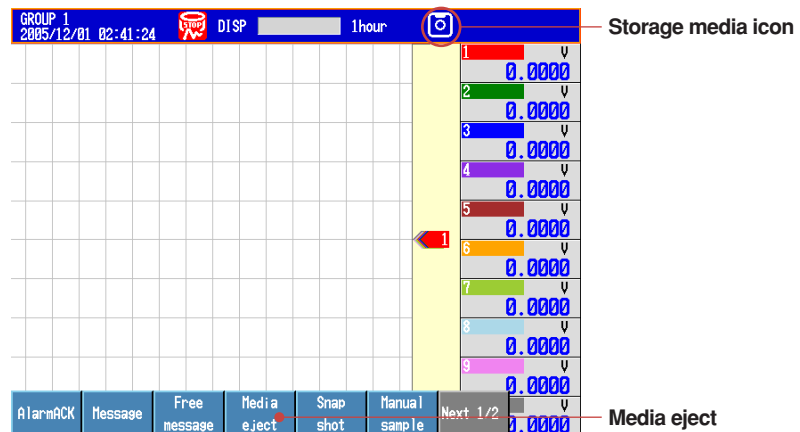

3. Press the **Media eject** soft key once.
4. Press the **CF** soft key once. The message “Media can be removed safely” appears.
5. Open the operation cover.
6. Press the CF card eject button. When you eject the CF card, the storage media icon disappears.

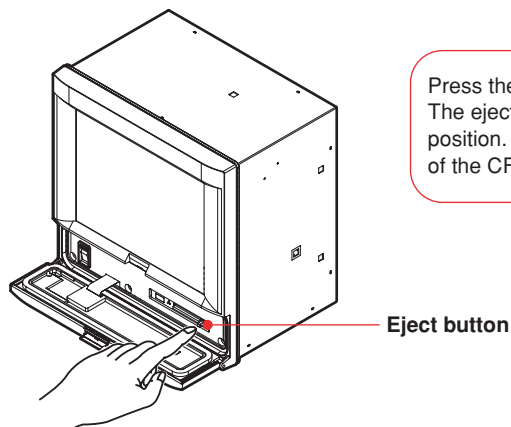

Press the eject button in until it clicks. The eject button stops at depressed position. Pinch the left and right side of the CF card and remove it.

7. Close the operation cover.

Operation complete.

<Operation in the Basic Setting Mode>

1. Press **MENU** (switch to the setting mode), hold down **FUNC** for 3 s (switch to the basic setting mode), select **Load settings, Initialize > Media eject > CF**, and press **DISP/ENTER**.

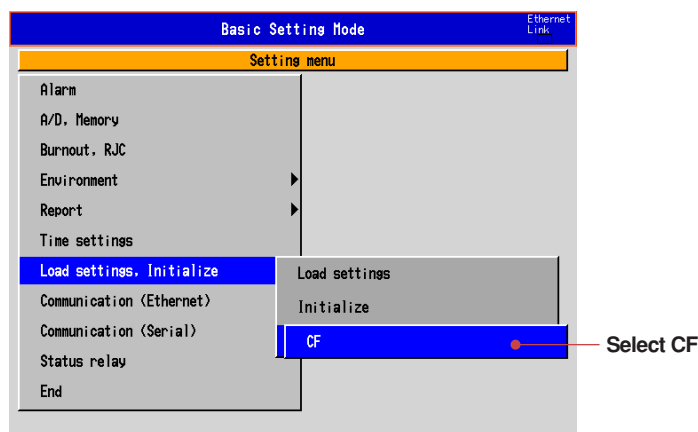

The message “Media can be removed safely” appears.

2. Open the operation cover.
3. Press the CF card eject button. Remove the CF card.
4. Close the operation cover.

Operation complete.

Note

If you remove the CF card without carrying out the media eject procedure, the message “Media was removed compulsorily” appears. Remove the CF card by carrying out the procedure above to prevent damaging the data that is stored.

Saving the Setup Data

In this example, we will save the setup data to a file named “SF2” on the CF card.

1. Display the operation mode screen.

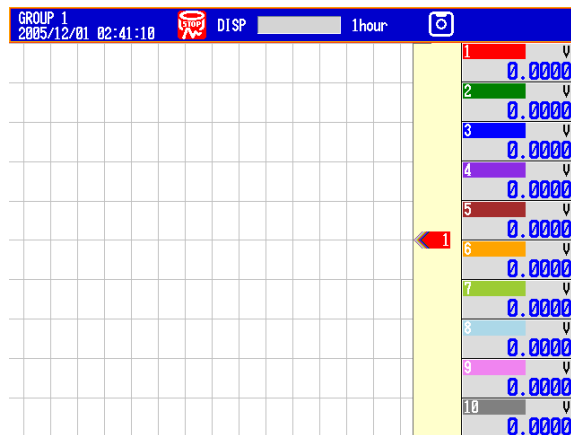

2. Press **MENU** once to display the setting menu.
3. Press the **up arrow key** twice to select **Save/Load**.
4. Press the **right arrow key** once and **down arrow key** three times.

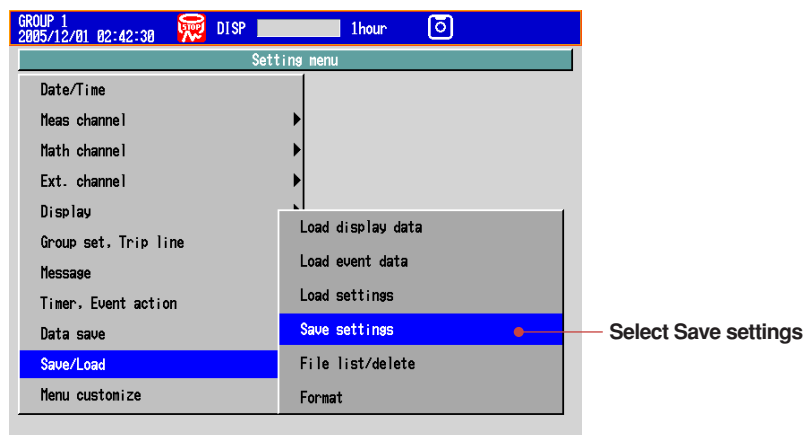

5. Press **DISP/ENTER** once.
6. Enter “SF2” for the file name.
For the input procedure, see “Entering Values and Characters” on page 18.

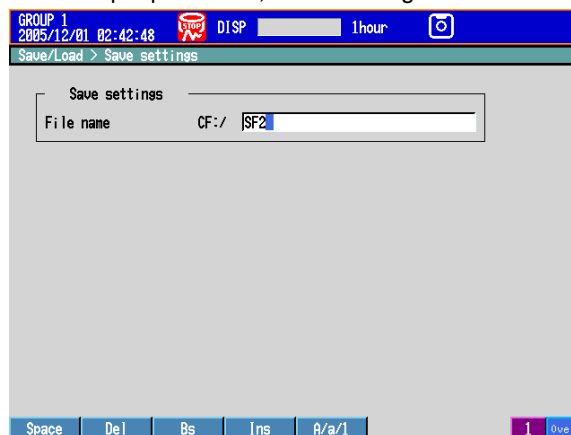

7. Press **DISP/ENTER** once. The message “Data are being saved to media” appears, and the setup data is saved.
8. Press **ESC** or **MENU** three times to return to the operation mode screen.

Operation complete.

Loading the Setup Data

In this example, we will load the setup data “SF2” from the CF card and update the DX settings. Here, only the setup data of the setting mode is loaded. To load the setup data of both the setting mode and basic setting mode, press **MENU**, hold down **FUNC** for 3 s, select **Load settings, Initialize > Load settings**, and press **DISP/ENTER**.

1. Display the operation mode screen.
2. Press **MENU** once to display the setting menu.
3. Press the **up arrow key** twice to select **Save/Load**.
4. Press the **right arrow key** once and **down arrow key** twice.

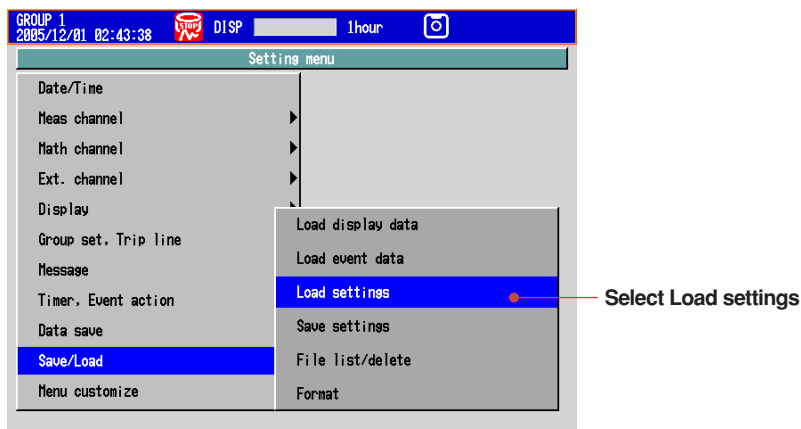

5. Press **DISP/ENTER** once to select the root directory (CF:/).
6. Press **DISP/ENTER** once to display the files in the root directory.
7. Select the file SF2.PDL using the up and down arrow keys.

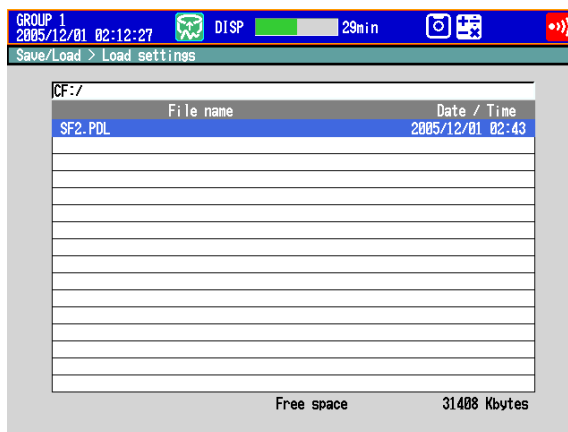

To move to a lower directory, select the directory, and press **DISP/ENTER**.

To move to a higher directory, press **ESC**.

8. Press **DISP/ENTER** once. The message “File is being loaded from media” appears, and the setup data is loaded. The DX automatically returns to the operation mode screen.

Operation complete.

Setting the Input Range and Alarm

Setup Example 1: Temperature Measurement Channel

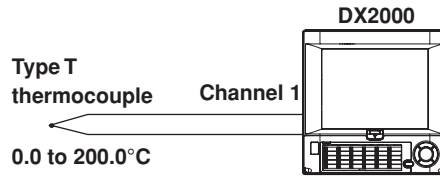

Setup Item	Description	Number in the Figure
Channel	Use channel 1.	1
Tag	TI-001	2
Sensor	Type T thermocouple	3
Input range	0.0 to 200.0°C	4

(1) Input Range

Press **MENU** (switch to the setting mode).

From the setting menu, select **Meas Channel > Range, Alarm**.

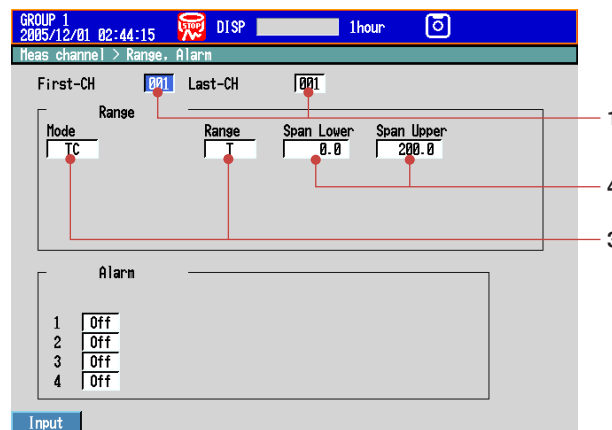

(2) Tag

From the setting menu, select **Meas Channel > Tag, Memory sample, Alarm delay**.

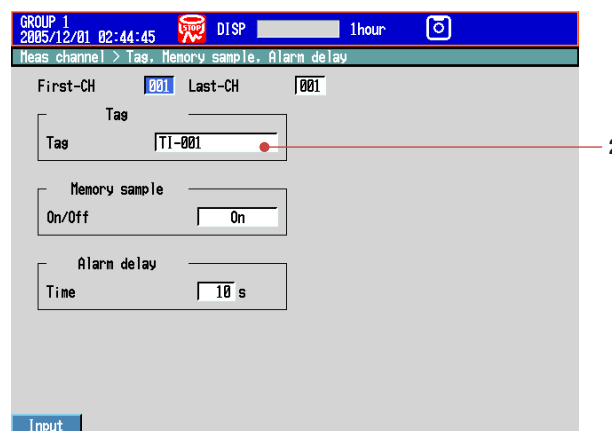

Operation complete.

Setup Example 2: Flow Rate Measurement Channel and Alarm

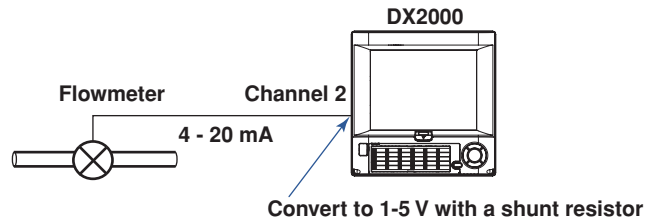

Setup Item	Description	Number in the Figure
Channel	Use channel 2.	1
Tag	FI-002	2
Input signal	1-5V	3
Input range	0.0 to 500.0 L/H	4
Alarm condition	Output an alarm if the measured value is less than or equal to 120.0 L/H. Output destination: Relay contact (I03)	5

(1) Input Range and Alarm

Press **MENU** (switch to the setting mode).

From the setting menu, select **Meas Channel > Range, Alarm**.

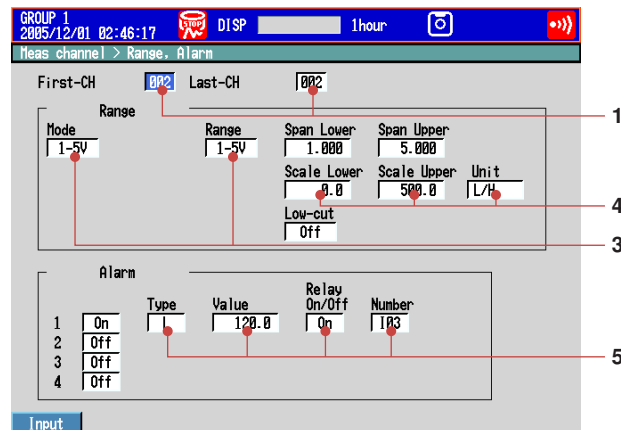

(2) Tag

From the setting menu, select **Meas Channel > Tag, Memory sample, Alarm delay**.

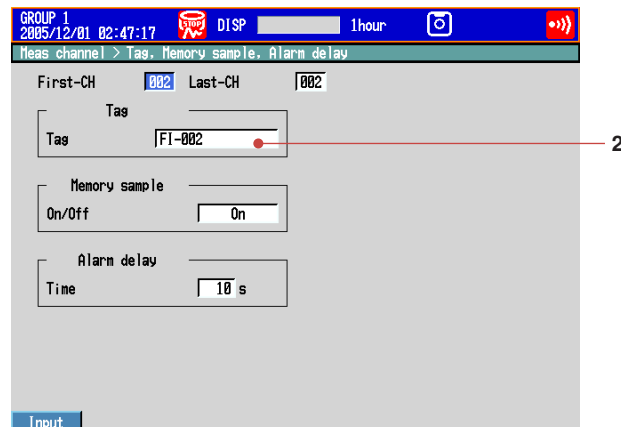

Operation complete.

Setting the Display

Setup Example 3: Assigning Channels to Groups

In this example, we will assign channels 1 and 2 to group 1.

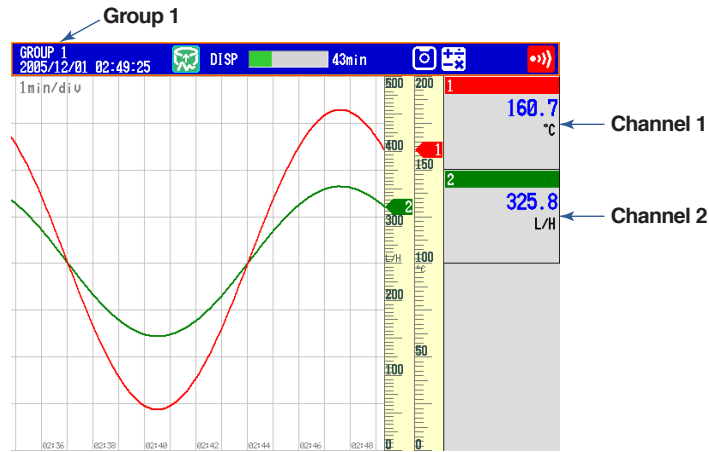

Setup Item	Description	Number in the Figure
Group	Assign channel 1 and 2 to group 1.	1

(1) Group

Press **MENU** key (switch to the setting mode) and select **Group set, Trip line**.

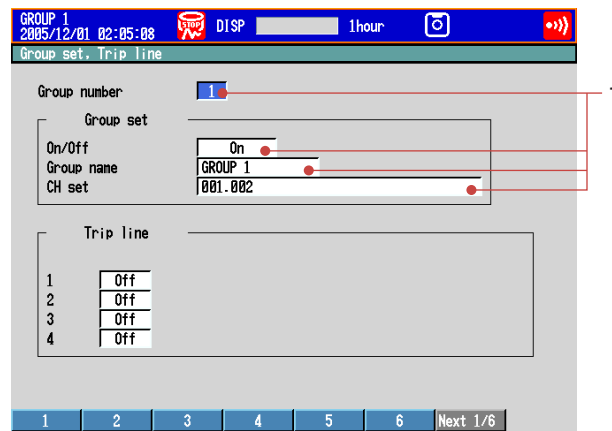

Operation complete.

Setup Example 4: Setting the Time Scale

Set the time per division of the trend waveform to 2 minutes.

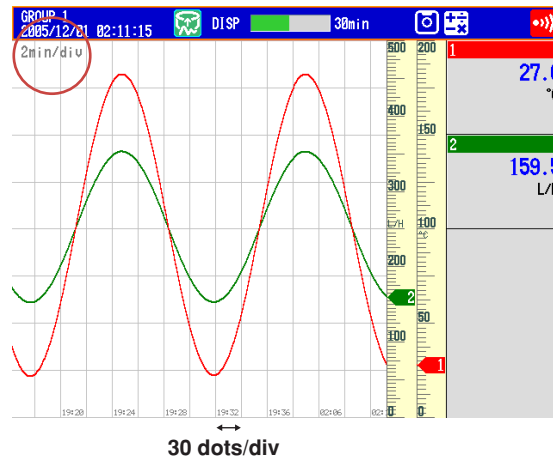

The sampling interval (the time corresponding to 1 dot) is 4 s when the trend interval is 2 min.
 $30 \text{ dots} \times 4 \text{ s} = 2 \text{ min}$

Setup Item	Description	Number in the Figure
Trend interval	Set the time per division to 2 minutes. The waveform is updated at every 4 s.	1

(1) Trend Interval

Press **MENU** (switch to the setting mode) and select **Display > Trend/Save interval**.

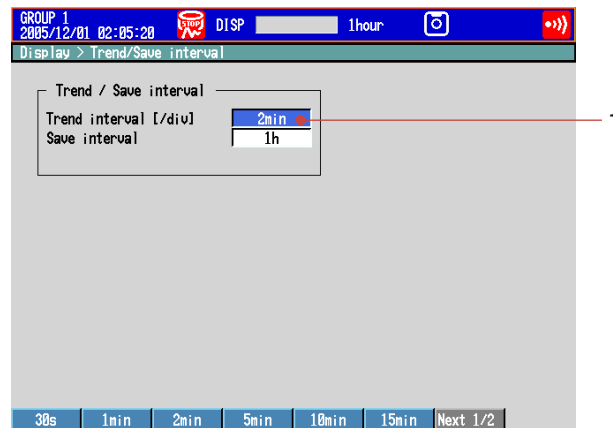

Operation complete.

Setting the Data Storage

Setup Example 5: Continuously Record Measured Data and Automatically Save

In this example, we will continuously record and save the measured data of channel 1 and 2.

For the procedure to set the channel, see “Setting the Input Range and Alarm” on page 28.

For the procedure to set groups, see “Setting the Display” on page 30.

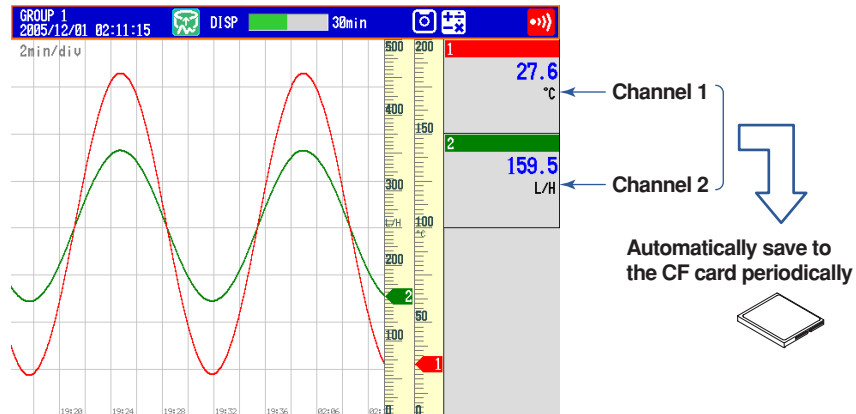

Setup Item	Description	Number in the Figure
Source channels	Channel 1 (TI-001) and channel 2 (FI-002)	1
Data to be recorded	Continuously record the display data from the start of the measurement.	2
Data storage method	Automatically store every 24 hours.	3
Sampling interval	4 seconds. Set using the trend update interval. Sampling interval = (trend update interval setting)/30 dots	4
Data file name	Add “sample” to the file name. Example: <u>000123</u> sampleYYMMDD_HHMMSS0.DAD ↑ ↑ Sequential number Date/Time of the first recorded data and 0 (zero)	5
Save Destination Directory	DATA-101	6

(1) Data to be Recorded

Press **MENU** (switch to the setting mode), hold down **FUNC** for 3 s (switch to the basic setting mode).

From the basic setting menu, select **A/D, Memory**.

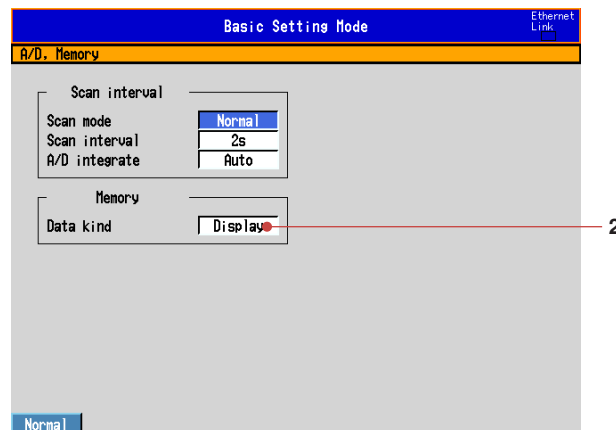

(2) Method of Storing to the CF Card (Auto Save ON/OFF)

Press **MENU** (switch to the setting mode), hold down **FUNC** for 3 s (switch to the basic setting mode).

From the basic setting menu, select **Environment > Security, Media save, Batch**.

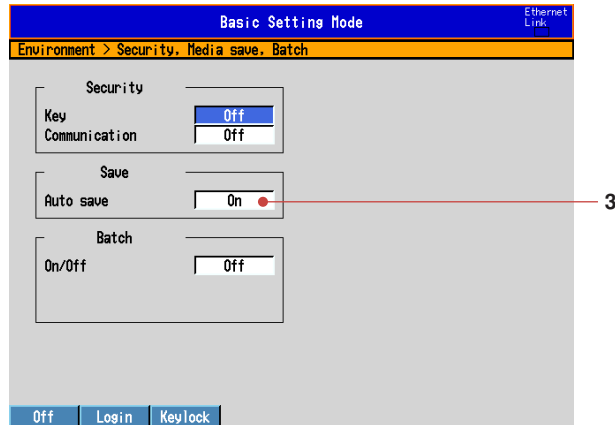

(3) Save the Settings

1. Press **ESC** to return to the basic setting menu.
2. Select **End** and press **DISP/ENTER**.
The window appears for you to confirm the saving of the settings.
3. Select **Yes** and press **DISP/ENTER**.
The DX returns to the operation mode screen.

(4) Channels to Be Recorded

Press **MENU** (switch to the setting mode).

From the setting menu, select **Meas Channel > Tag, Memory sample, Alarm delay**.

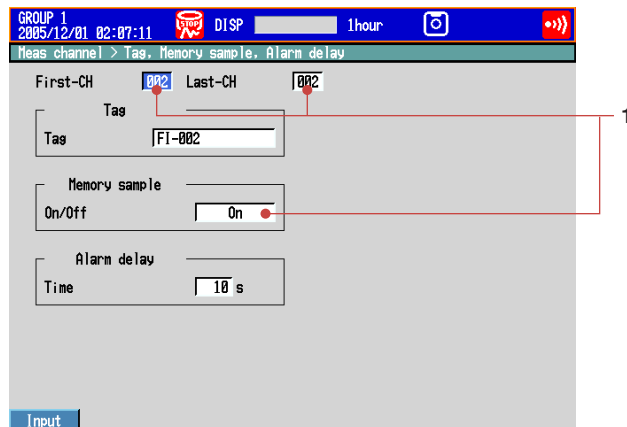

(5) Interval for Saving the Data to the CF Card

From the setting menu, select **Display > Trend/Save interval**.

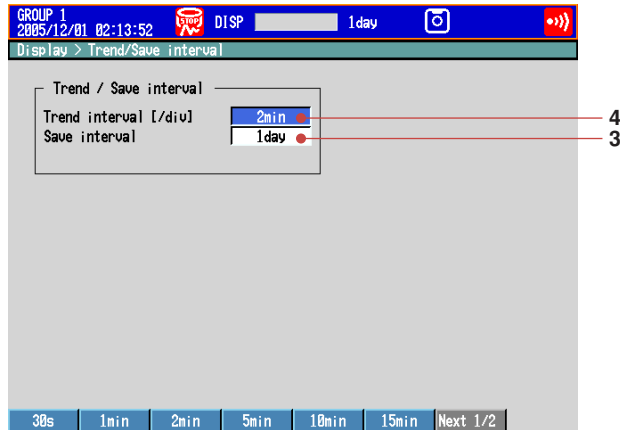

(6) Data File Name

From the setting menu, select **Data save > File header, Data file name**.

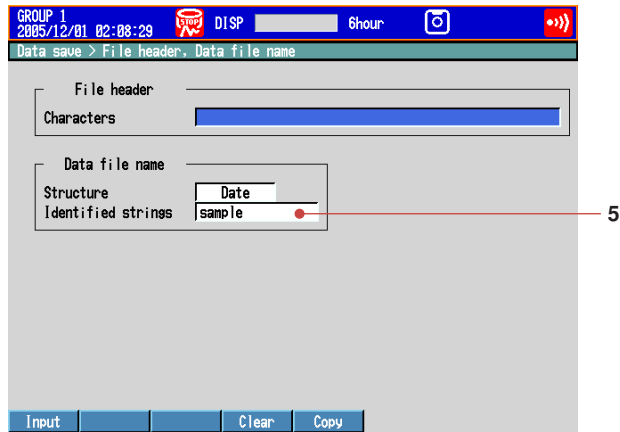

(7) Save Destination Directory (within the CF Card)

From the setting menu, select **Data save > Save directory**.

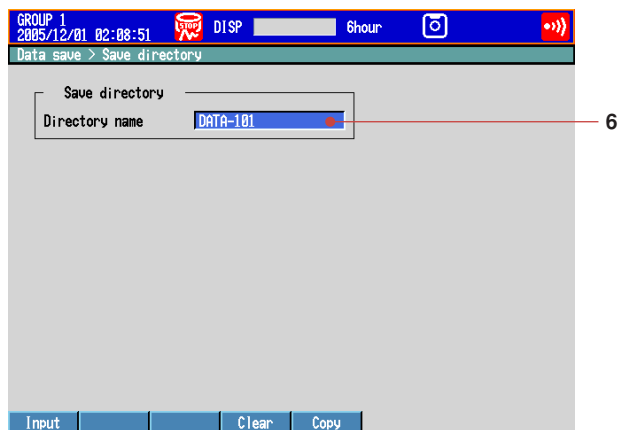

Operation complete.

Setup Example 6: Saving Measured Data at the Specified Time

Using the settings of Setup Example 5, we will save the measured data once at hour 0 every day.

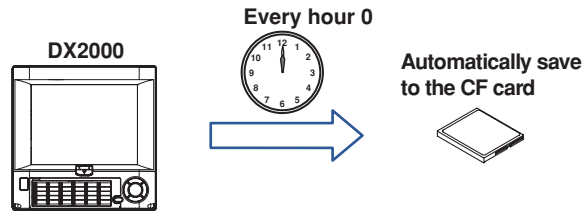

All settings other than those listed below are the same as Setup Example 5.

Setup Item	Description	Number in the Figure
Data storage time	Save the data once at hour 0 every day.	7
Data storage method	Automatically save the measured data at the specified time.	8

(1) Setting the Time

Press **MENU** (switch to the setting mode).

From the setting menu, select **Timer, Event action > Match time timer**.

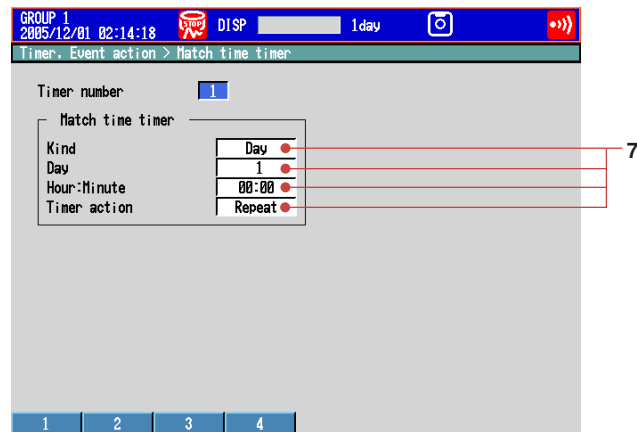

(2) Specifying the Data Storage

Press **MENU** (switch to the setting mode).

From the setting menu, select **Timer, Event action > Event action**.

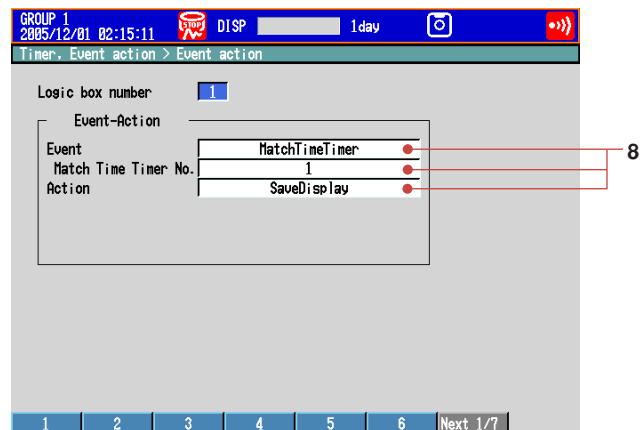

Operation complete.

Customizing the Operation

Setup Example 7: Assigning the Screen Image Data Storage Function to the USER key

In this example, we will set the DX so that the displayed screen image data can be saved to the CF card by pressing the USER key. This function is called *snapshot*. The extension of snapshot data files is .png.

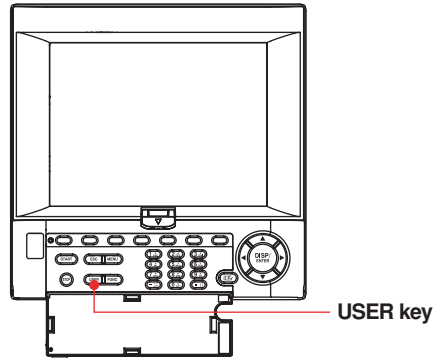

Setup Item	Description	Number in the Figure
Event action	Save the screen image data of the DX using the USER key.	1

(1) Assigning an Action to the USER Key

Press **MENU** (switch to the setting mode) and select **Timer, Event action > Event action**.

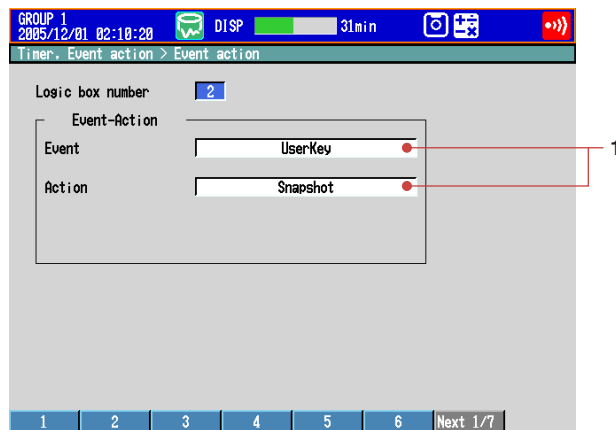

Operation complete.

Setup Example 8: Registering Frequently Used Screens to the Favorite Key

Up to eight operation mode screens that are frequently used can be registered to the Favorite key. This enables you to monitor the operation by using only the Favorite key. This feature is convenient when comparing data such as historical trends.

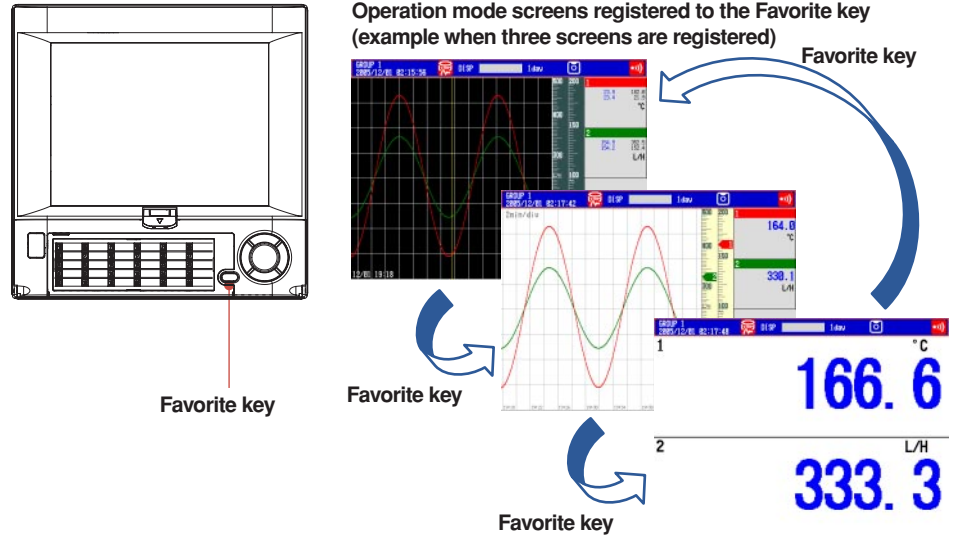

1. Display the screen to be registered.

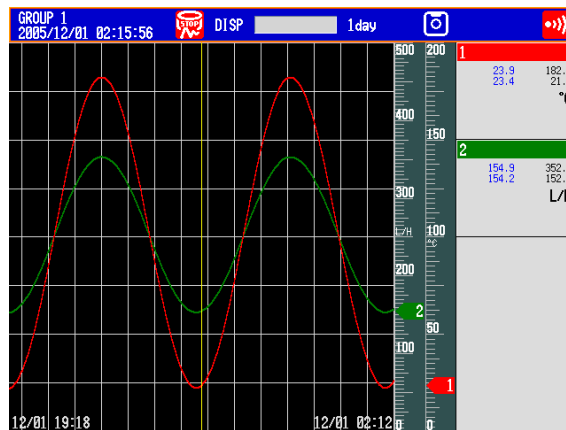

2. Press **FUNC** once to display the FUNC key menu.
3. Press the **Next** soft key to display Favorite regist.
4. Press the **Favorite regist** soft key to display the registration list window.

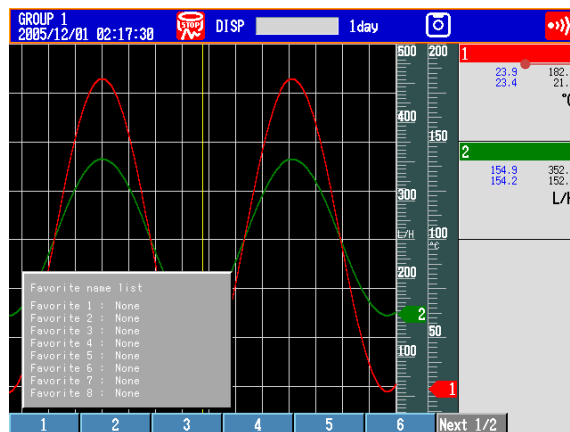

Register the historical trend to the Favorite key

Customizing the Operation

5. Press the favorite number (1 to 8) soft key.
6. Press the **Register** soft key.

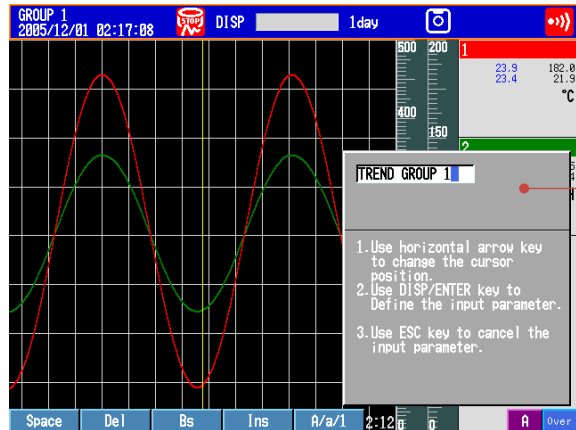

Show the window for entering the display name

7. Enter the screen name.
Select the digit: **Left and right arrow keys**
Enter characters: **Character/Number input keys**
Delete a character: **Space soft key**
Cancel the setting: Press **ESC** before pressing **DISP/ENTER**.
For the input procedure, see "Entering Values and Characters" on page 18.
8. Press **DISP/ENTER** once.
9. Repeat steps 1 to 8 to register up to eight screens.

Operation complete.

Operation

Starting the Memory Sample

1. Press **START** once.
Memory sample starts.

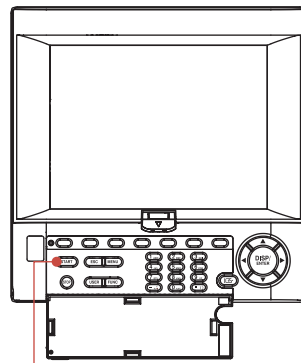

START key

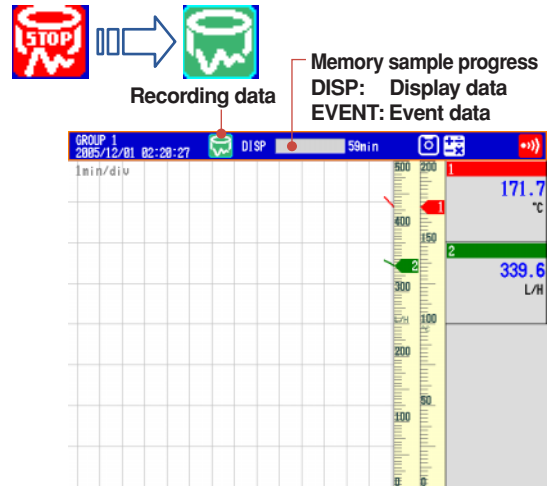

Operation complete.

Stopping the Memory Sample

1. Press **STOP** once.

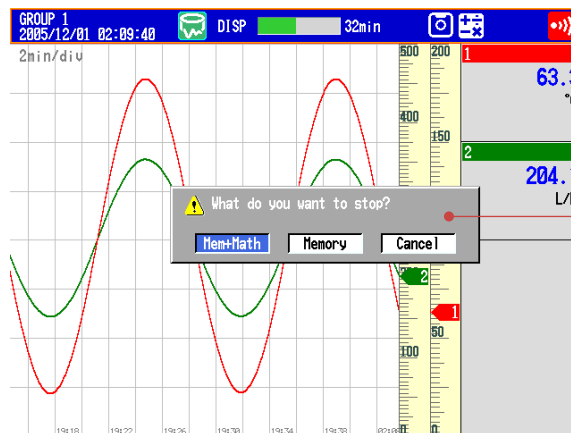

Display the confirmation window

2. Select **Mem+Math** or **Memory** using the left and right arrow keys.
Memory: Stops memory sample.
Mem+Math: Stops memory sample and computation (option).
On models without the computation function (option), the confirmation message "Do you want to stop data storage?" appears. Select **Yes**.
3. Press **DISP/ENTER** once.



Stop memory sampling.

Operation complete.

Switching the Trend Display, Digital Display, and Bar Graph Display

1. Press **DISP/ENTER** once to show the display selection menu.

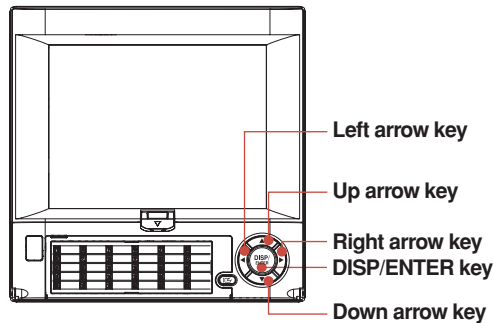

2. Press the **down arrow key** to select **TREND**, **DIGITAL**, or **BAR**.
3. Press the **right arrow key** once to display the sub menu. To close the sub menu that you opened, press the **left arrow key**.
4. Press the **down arrow key** to select the group.

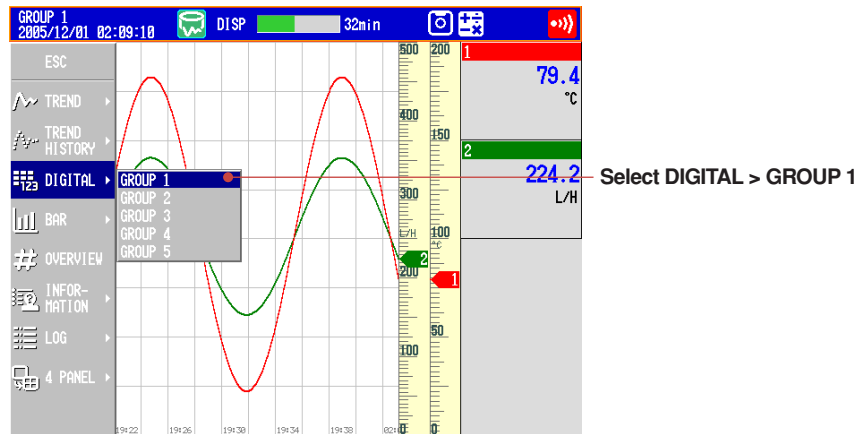

5. Press **DISP/ENTER** once to show the operation display of the selected group. To close the menu without switching the display, press **ESC**.

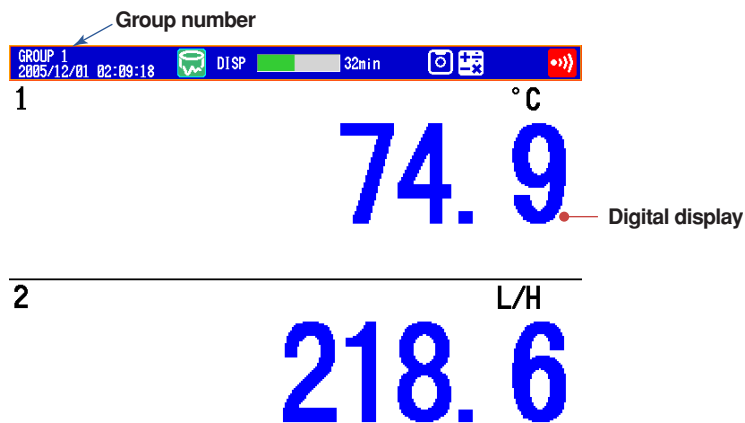

Operation complete.

Press the **down arrow key** when the trend, digital, or bar graph is displayed to switch the display in the order trend, digital, bar graph, trend, and so on. Press the **up arrow key** to switch the display in reverse order. Press the **right arrow key** or the **left arrow key** to switch the group.

Writing the Message “START”

Registering the Word “START” in Message Number 1

1. Press **MENU** (switch to the setting mode) and select **Message**. Press **DISP/ENTER**, the **down arrow key** once, and the **Input** soft key to show the message registration window.

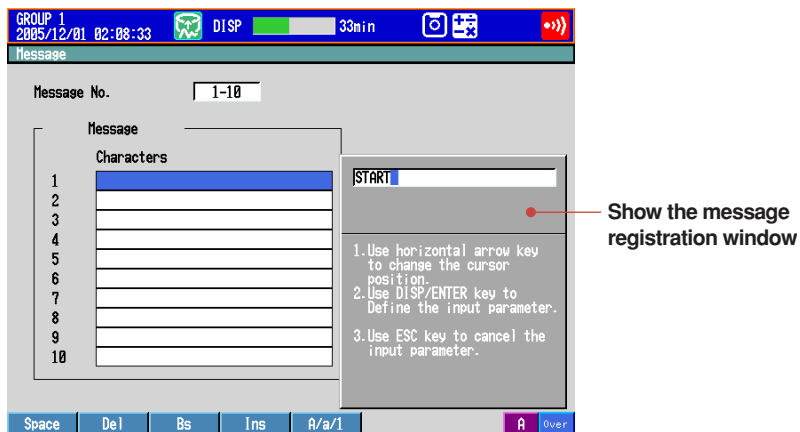

Select the digit: **Left and right arrow keys**

Enter characters: **Character/Number input keys**

Delete a character: **Space soft key**

Cancel the setting: Press **ESC** before pressing **DISP/ENTER**.

For the input procedure, see “Entering Values and Characters” on page 18.

2. Press **DISP/ENTER**.



3. Press **ESC** or **MENU** twice to return to the operation mode screen.

Operation complete.

Writing Message Number 1 "START"

This operation can be carried out while memory sample is in progress. The message is displayed on the trend display. Show the trend display first.

1. Press **FUNC** (display the FUNC key menu), press the **Message** soft key, and press the **1 - 10** soft key.

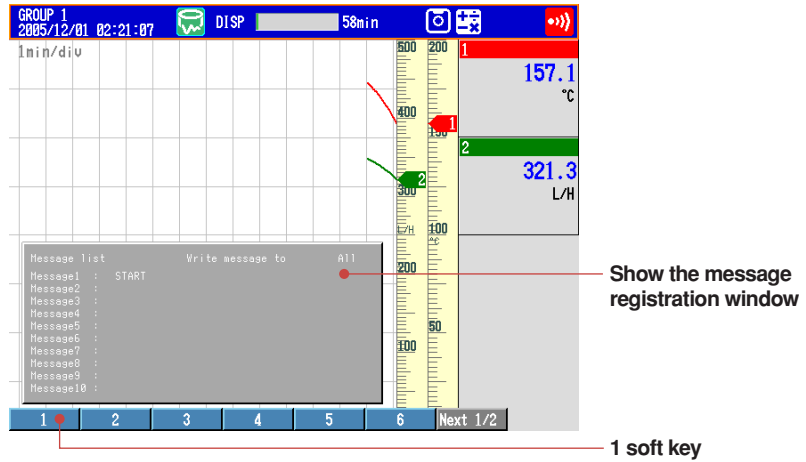

2. Press the **1** soft key.

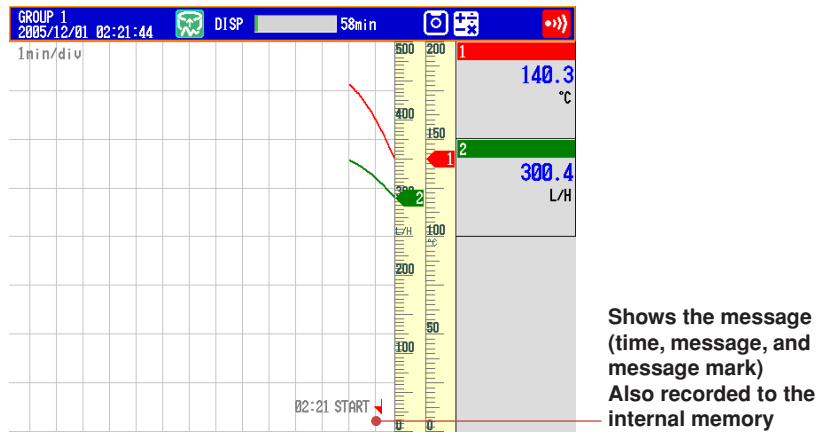

Operation complete.

Connecting to an Ethernet Network

Setup Example 9: Monitoring the DX on a PC Browser

In this example, we will connect the PC and the DX via hub in a one-to-one relationship and display and monitor the DX screen on a browser on the PC.

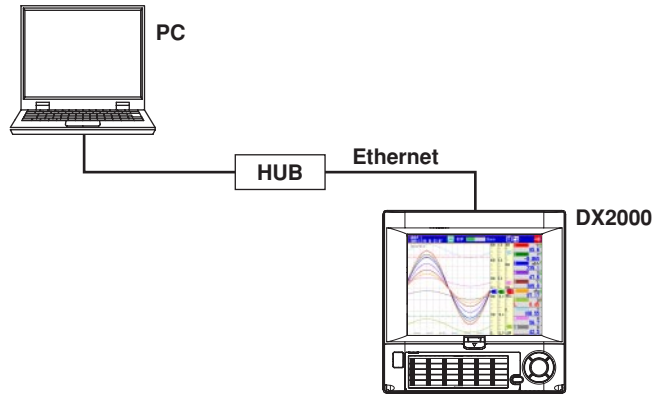

DX

Setup Item	Description	Number in the Figure
IP address	192.168.1.101	1
Subnet mask	255.255.255.0	
Web server function	Monitor from a Web browser on the PC using operator page.	2
Access to the DX	Display the Web page and do not set access privileges.	3

PC

Setup Item	Description	Number in the Figure
IP address	192.168.1.100	4
Subnet mask	255.255.255.0	

(1) IP Address of the DX

Press **MENU** (switch to the setting mode), hold down **FUNC** for 3 s (switch to the basic setting mode).

From the basic setting menu, select **Communication (Ethernet) > IP address, Host settings**.

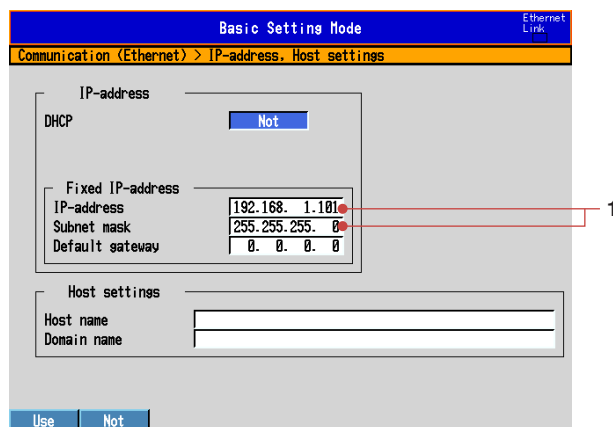

(2) Enabling the Web Server Function on the DX

From the basic setting menu, select **Communication (Ethernet) > Server**.

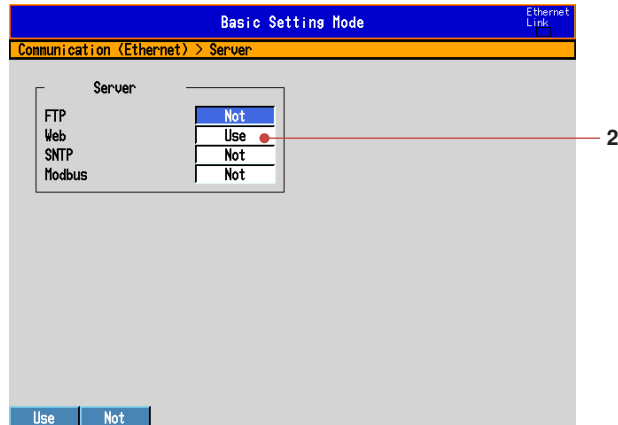

(3) Display the DX Screen on the PC

From the basic setting menu, select **Communication (Ethernet) > Web page**.

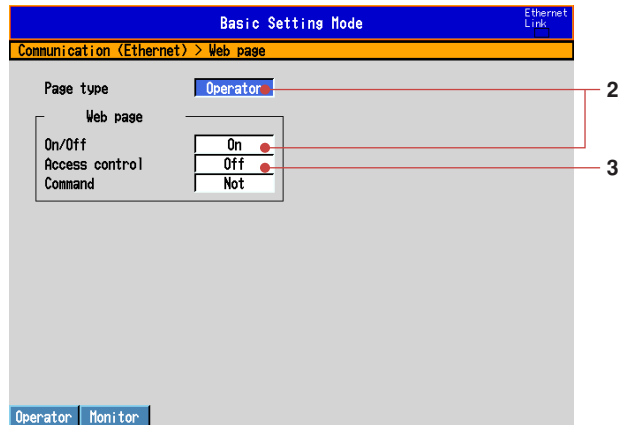

(4) Save the Settings

1. Press **ESC** to return to the basic setting menu.
2. Select **End** and press **DISP/ENTER**.
The window appears for you to confirm the saving of the settings.
3. Select **Yes** and press **DISP/ENTER**.
The DX returns to the operation mode screen.

(5) Setting the PC

Set the IP address and subnet mask on the PC.

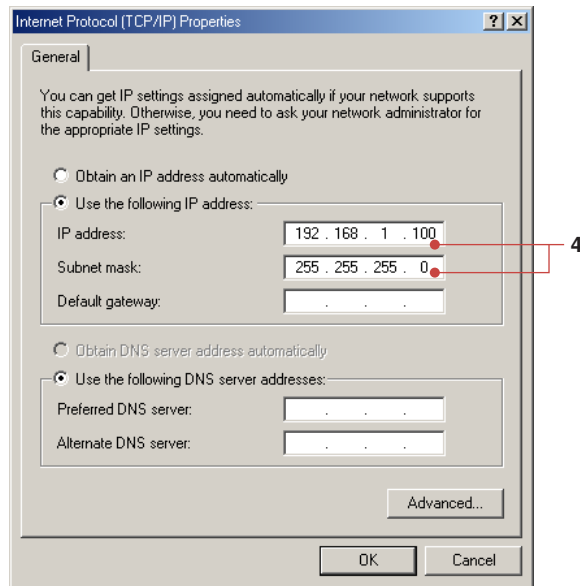

(6) Checking the Connection

Send the command below from the PC and check that a correct response is returned.

Send

>ping 192.168.1.101

Response example

>Reply from 192.168.1.101: bytes=32 time<10ms TTL=255

(7) Displaying the DX Screen on the Browser

1. Start the browser on the PC.
2. Enter the following URL.
http://192.168.1.101/operator.htm
3. Check that the DX screen appears.

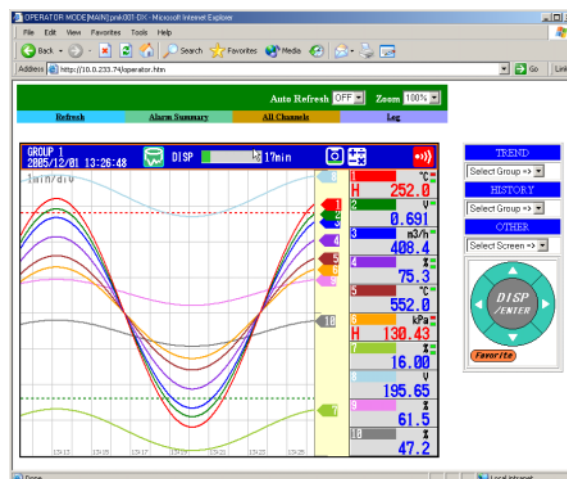

Operation complete.

Setup Example 10: Automatically Transferring the Measured Data File to an FTP Server

In this example, we will configure the DX so that the measured data is automatically transferred to an FTP server on the network when the measured data is automatically saved to the CF card. To automatically transfer the measured data files and report files, the auto saving of the measured data must be configured in advance (see “Data storage method” of the setup example 5).

This example assumes that the following network environment is used: DHCP enabled, automatically obtain the DNS server information, and automatically register the DX host name to the DNS server. Set the parameters according to your network environment.

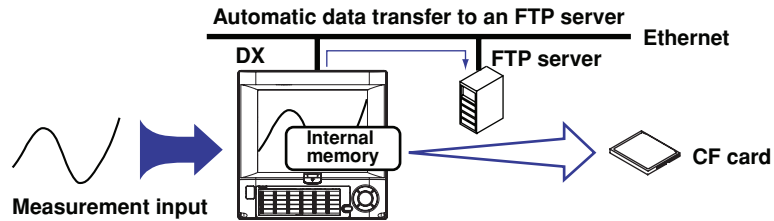

Setup Item	Description	Number in the Figure
Host name	DAQSTATION1	1
Obtain the IP address	Obtain automatically (DHCP)	2
Type of data to be transferred	Acquired measured data	3
FTP server	Server name abcdefg.co.jp	4
	Port number 21	
	Login name FTPUSER1	
	Password a1234	

(1) Host Settings and IP Address of the DX

Press **MENU** (switch to the setting mode), hold down **FUNC** for 3 s (switch to the basic setting mode).

From the basic setting menu, select **Communication (Ethernet) > IP address, Host settings**.

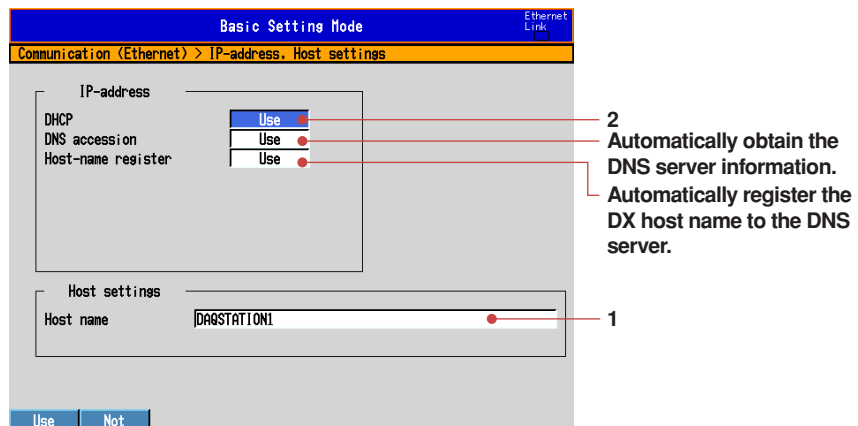

(2) Data to Be Transferred to the FTP Server and the FTP Server

From the basic setting menu, select **Communication (Ethernet) > FTP client**.

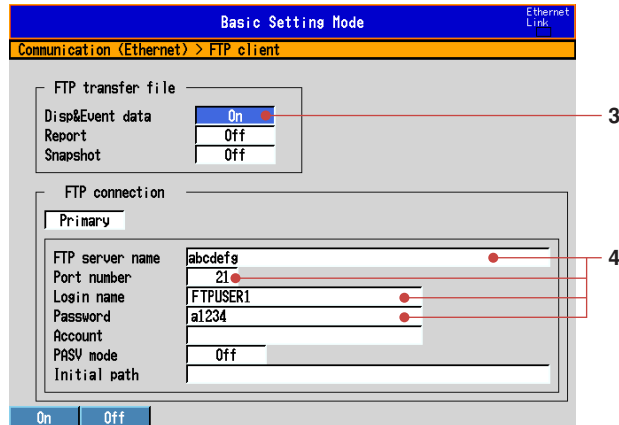

(3) Save the Settings

1. Press **ESC** to return to the basic setting menu.
2. Select **End** and press **DISP/ENTER**.
The window appears for you to confirm the saving of the settings.
3. Select **Yes** and press **DISP/ENTER**.
The DX returns to the operation mode screen.

Operation complete.

Executing a File Transfer Test

1. Press **FUNC** once to display the FUNC key menu.
2. Press the **FTP test** soft key once.

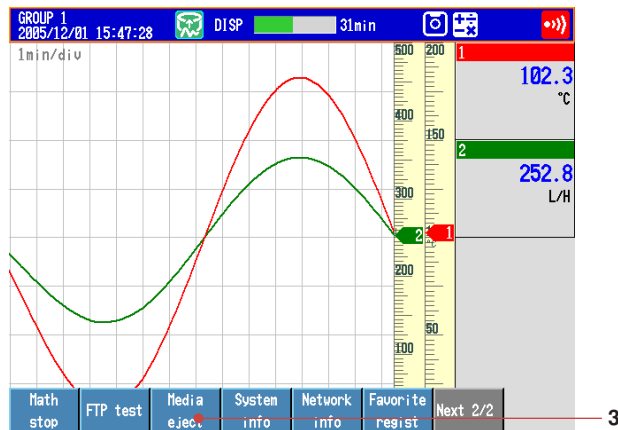

3. Press the **Primary** soft key once. The messages “FTP test is being executed” and “Execution is complete” are displayed. The test file (FTP_TEST.TXT) is sent to the FTP server.

Operation complete.

Transferring the Data Files

When you start memory sample, the measured data file is transferred to the FTP server when the data is saved to the CF card.

Using DAQSTANDARD

Displaying the Measured Data on DAQSTANDARD

In this example, we will display the measured data using the accompanying software program, DAQSTANDARD.

1. Insert the CF card containing the measured data file (.DAD or .DAE extension) into the PC that has DAQSTANDARD installed.
2. Start DAQSTANDARD. The launcher is displayed.

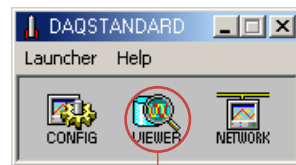

Data viewer icon

3. Click the data viewer icon to start the data viewer.

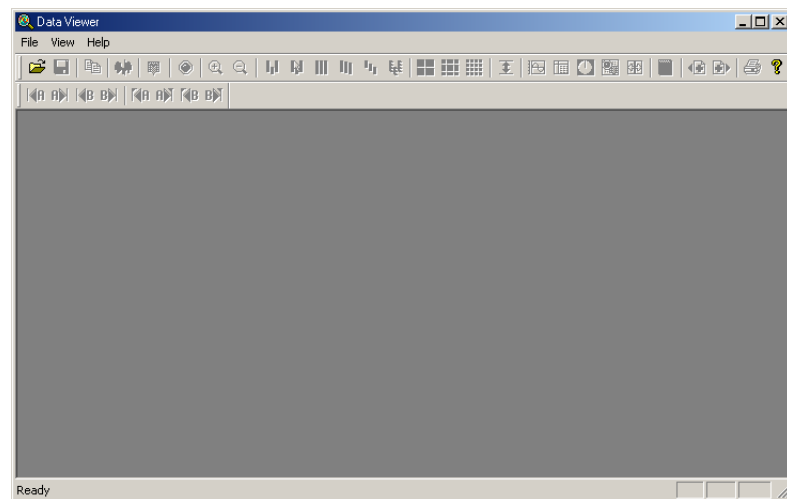

4. From the **File** menu, choose **Open**.
5. In the Open dialog box, select the desired file, and click **Open**. The data is displayed.

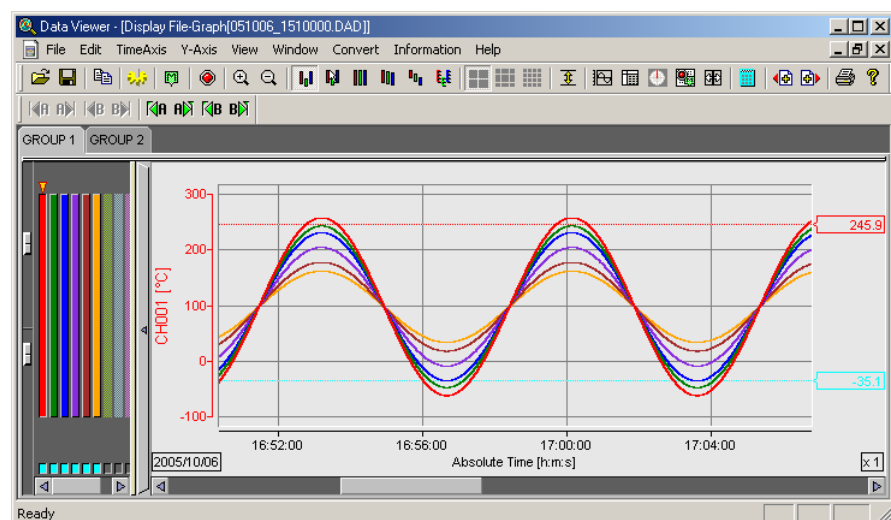

Operation complete.

Installation and Wiring

Installation Location

Install the DX indoors in a location that meets the following conditions.

- **Instrumentation Panel**

The DX is designed to be installed in an instrumentation panel except for the desktop type.

- **Well-Ventilated Location**

To prevent overheating, install the DX in a well-ventilated location. For the panel cut dimensions when arranging multiple DXs, see the page 54. Follow the panel cut dimensions providing adequate space between instruments when other instruments are arranged on the panel. For the desktop type, we recommend that a space of at least 50 mm be provided around the left, right, and top panels of the DX.

- **Minimum Mechanical Vibrations**

Choose an installation location with the minimum mechanical vibration. Installing the DX in a location with large mechanical vibration not only causes adverse effects on the mechanism but also may hinder normal recording.

- **Horizontal**

Install the DX horizontally (However, the DX can be inclined up to 30 degrees backwards for panel mounting).

Note

Condensation may occur if the DX is moved to another place where the ambient temperature is higher, or if the temperature changes rapidly. In addition, measurement errors will result when using thermocouples. If this happens, let the DX adjust to the new environment for at least one hour before using it.

Do not install the DX in the following places.

- **Outdoors**

- **In Direct Sunlight or Near Heat Sources**

Install the DX in a place with small temperature fluctuations near room temperature (23°C). Placing the DX in direct sunlight or near heat appliances can cause adverse effects on the internal circuitry.

- **Where an Excessive Amount of Soot, Steam, Moisture, Dust, or Corrosive Gases Are Present**

Soot, steam, moisture, dust, and corrosive gases will adversely affect the DX. Avoid such locations.

- **Near Strong Magnetic Field Sources**

Do not bring magnets or instruments that produce electromagnetic fields close to the DX. Operating the DX in strong magnetic fields can cause errors in the measurements.

- **Where the Viewing of the Display Is Poor**

The DX uses a TFT color LCD for the display. Therefore, viewing of the display from an extreme angle is difficult. Install the DX so that the user can view the display from the front.

Installation Procedure

Installation Procedure (Panel Mount Type)

Use a steel panel of thickness 2 mm to 26 mm.

1. Insert DX from the front of the panel.
2. Mount the DX to the panel using the mounting brackets that come with the package as shown in the figure below.
 - Use two brackets to support the top and bottom or the left and right sides of the case (remove the seal that is covering the holes for the mounting brackets beforehand).
 - The proper torque for tightening the mounting screws is 0.7 to 0.9 N-m.
 - Mount the DX to the rack according to the procedure below.
 - First, attach the two mounting brackets and temporarily fasten the attachment screws.
 - Next, fix the DX in place by tightening the attachment screws with the appropriate torque. When the DX is approximately perpendicular to the panel as you fasten the screws, press the mounting bracket against the case so that they are in contact with each other.



CAUTION

- Tightening the screws too much can deform the case or damage the bracket.
- Be careful not to insert foreign objects or tools through the holes for the mounting brackets in the case.

Panel Mounting Diagram

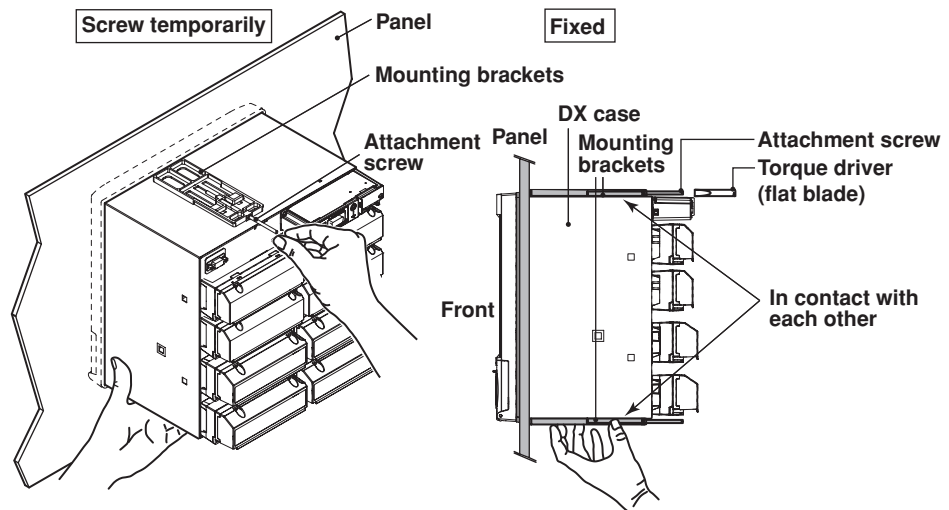

(The figure shows the case when the mounting brackets are used on the top and bottom of the case.)

Note

To achieve sufficient dust and water proof performance, mount the DX in the middle of the panel cut out.

External Dimensions and Panel Cut Dimensions
Panel Mount Type

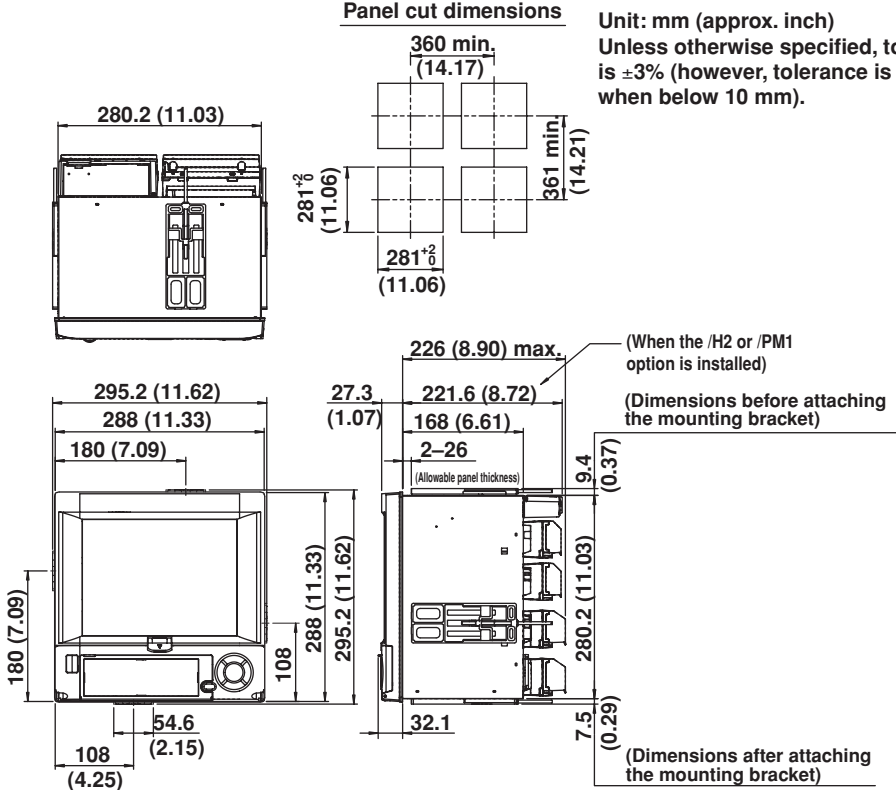

Desktop Type (/H5 [] Option)

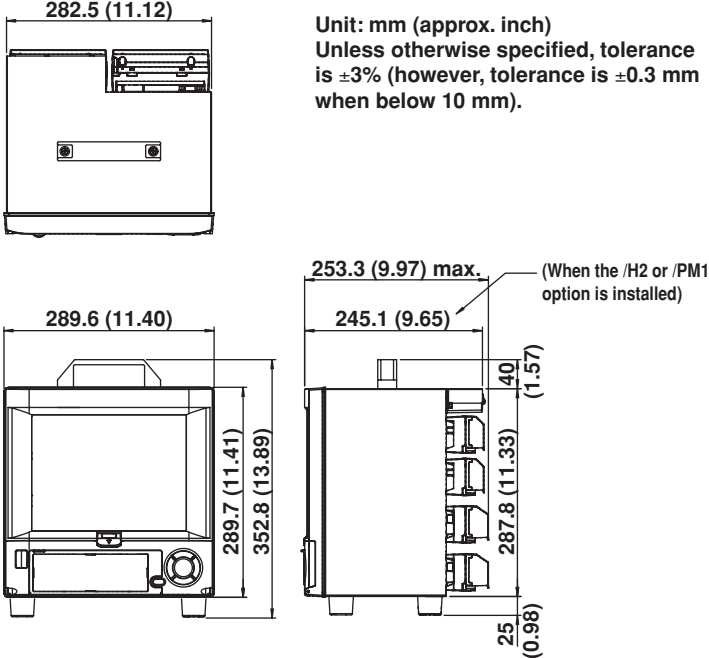

Installation and Wiring

Input Signal Wiring



WARNING

- To prevent electric shock while wiring, ensure that the power supply source is turned OFF.

CAUTION

- If a strong tension is applied to the cable wired to the DX, the terminals of the DX and/or the cable can be damaged. In order to prevent tension from being applied directly on the terminals, fasten all wiring cables to the rear of the mounting panel.
- To prevent fire, use signal wires having a temperature rating of 70°C or more.
- Do not apply a voltage exceeding the following value to the input terminals. Otherwise, damage to the DX may result.
 - Maximum input voltage: ± 60 VDC
 - Maximum common mode voltage: ± 60 VDC (under measurement category II conditions)
- The DX is a product of installation category II.

Precautions to Be Taken While Wiring

Take the following precautions when wiring the input signal cables.

It is recommended that crimp-on lug with insulation sleeves (designed for 4-mm screws) be used when connecting the input/output signal wires to the terminals. However, this does not apply clamped terminals (/H2).



Crimp-on lug with insulation sleeves (for 4 mm screws)

For clamped terminals (/H2), the following wire is recommended.

- Conductive cross-sectional area: 0.08 mm^2 to 1.5 mm^2 (AWG 28 to 16)
- Length of the stripped section of the wire: Approx. 7 mm

Take measures to prevent noise from entering the measurement circuit.

- Move the measurement circuit away from the power cable (power circuit) and ground circuit.
- It is desirable that the object being measured does not generate noise. However, if this is unavoidable, isolate the measurement circuit from the object. Also, ground the object being measured.
- Shielded wires should be used to minimize noise caused by electrostatic induction. Connect the shield to the ground terminal of the DX as necessary (make sure you are not grounding at two points).
- To minimize noise caused by electromagnetic induction, twist the measurement circuit wires at short, equal intervals.
- Make sure to earth ground the protective ground terminal through minimum resistance (less than 100Ω).

When using internal reference junction compensation on the thermocouple input, take measures to stabilize the temperature at the input terminal.

- Always use the terminal cover.
- Do not use thick wires which may cause large heat dissipation (cross sectional area of 0.5 mm^2 or less recommended).
- Make sure that the ambient temperature remains reasonably stable. Large temperature fluctuations can occur if a nearby fan turns ON or OFF.

Connecting the input wires in parallel with other devices can cause signal degradation, affecting all connected devices. If you need to make a parallel connection, then

- Turn the burnout detection function OFF.
- Ground the instruments to the same point.
- Do not turn ON or OFF another instrument during operation. This can have adverse effects on the other instruments.
- RTDs cannot be wired in parallel.

Wiring Procedure

A terminal cover is screwed in place on the measuring input terminal block on the rear panel. A label indicating the terminal arrangement is affixed to the cover.

1. Turn OFF the DX and remove the terminal cover.
2. Connect the signal wires to the terminals.
3. Replace the terminal cover and fasten it with screws. The proper torque for tightening the screws is 0.6 N-m.

Note

Input signal wires of diameter less than or equal to 0.3 mm may not be secured firmly for clamped terminals (/H2). Fold over the conducting section of the wire, for example, to make sure that the wire is securely connected to the clamped terminal.

Arrangement of the Input Terminals

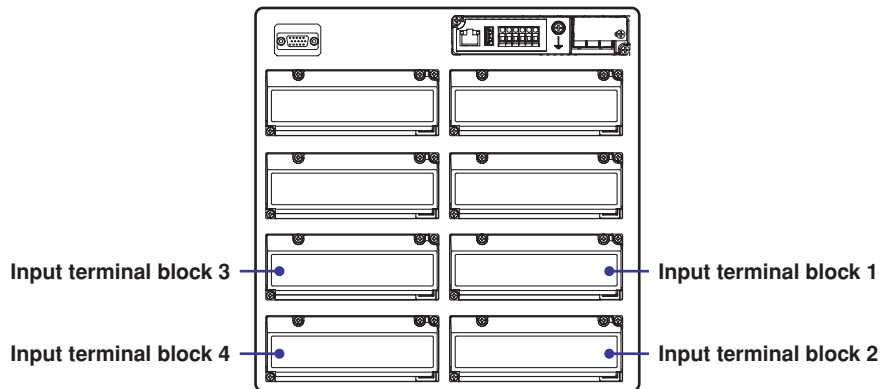

Block position	Channel Assignments by Model						
	DX2004	DX2008	DX2010	DX2020	DX2030	DX2040	DX2048
1	1-4	1-4	1-10	1-10	1-10	1-10	1-12
2		5-8		11-20	11-20	11-20	13-24
3					21-30	21-30	25-36
4						31-40	37-48

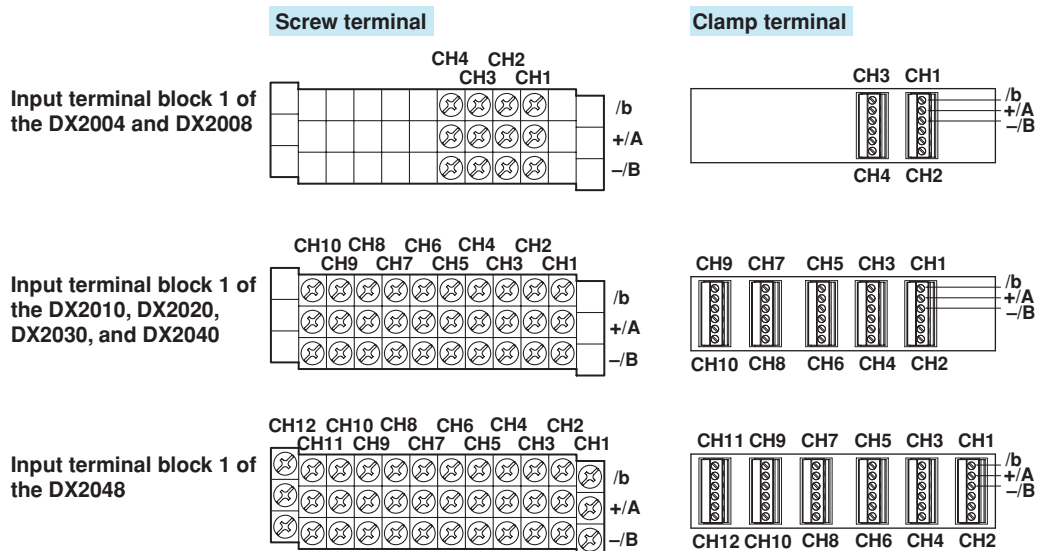

Installation and Wiring

Wiring Screw Terminals

DC voltage input/DI (ON/OFF) input

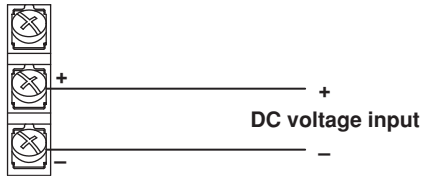

TC input

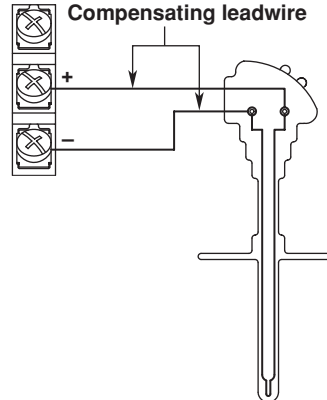

RTD input

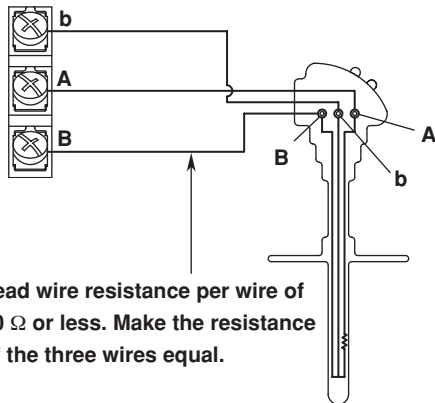

DC current input

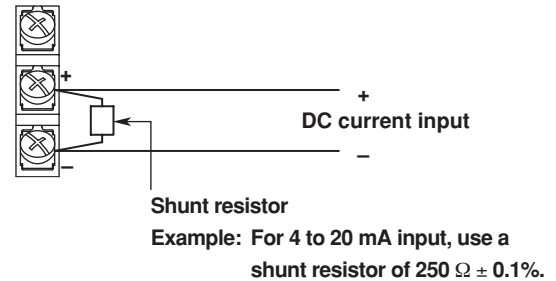

Wiring Clamped Terminals

Remove the terminal block
Hold both ends of the terminal block and pull straight.

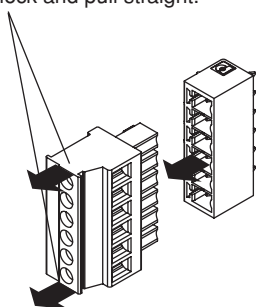

Connect the wires

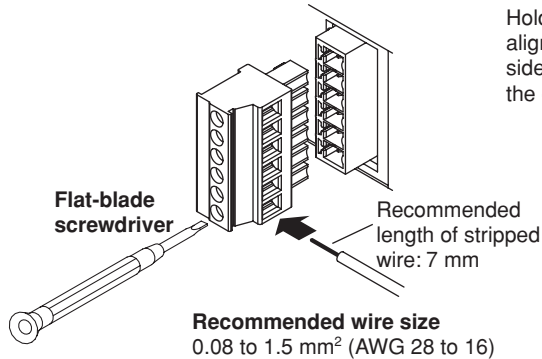

Connect the terminal block

Hold both ends of the terminal block, align with the connector on the DX side, and push the terminal block into the connector.

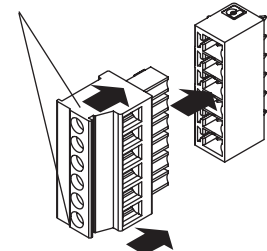

Input signal wire

First, loosen the screw at the front using a flat-blade screwdriver. Insert the input signal wire into the slit on the right side of the terminal block, and fasten the screw at the front.

Note

RTD input terminals A and B are isolated on each channel. Terminal b is shorted internally across all channels. However, terminal b is also isolated on each channel on models with the /N1 option (Cu10, Cu25 RTD input/3 leg isolated RTD) and /N2 option (3 leg isolated RTD).

Optional Terminal Wiring



WARNING

- To prevent electric shock while wiring, ensure that the power supply source is turned OFF.
- If a voltage of more than 30 VAC or 60 VDC is to be applied to the output terminals, use ring-tongue crimp-on lugs with insulation sleeves on all terminals to prevent the wires from slipping out when the screws become loose. Furthermore, use double-insulated wires (dielectric strength of 2300 VAC or more) for the signal wires on which a voltage of more than 30 VAC or 60 VDC is to be applied. For all other wires, use basic insulated wires (dielectric strength of 1390 VAC). To prevent electric shock, attach the terminal cover after wiring and make sure not to touch the terminals.

CAUTION

- Use the following circuit voltage for the connection to the alarm/FAIL/status output terminal.
 - When the connection is to Mains Circuits (primary AC power source circuits): 150 V or less
 - When the connection is to circuits derived from Mains Circuits (secondary circuits): 250 V or less (Mains Circuits voltage is less than 300 V, and connection must be used by isolation transformer.)
- To prevent fire, use signal wires having a temperature rating of 70°C or more.
- If a strong tension is applied to the cable wired to the DX, the terminals of the DX and/or the cable can be damaged. In order to prevent tension from being applied directly on the terminals, fasten all wiring cables to the rear of the mounting panel.
- Do not short the transmitter power supply output terminal or apply external voltage to it. If you do, the DX may malfunction.
- When using the transmitter power supply output terminal, do not use current that exceeds the maximum output current (25 mA DC). If you do, the DX may malfunction.
- Do not short the VIDEO OUT terminal or apply external voltage to it. If you do, the DX may malfunction.

Note

For remote control wiring, use shielded wires to reduce noise. Connect the shield to the functional ground terminal or the ground terminal of the DX.

Precautions to Be Taken While Wiring

It is recommended that crimp-on lug with insulation sleeves (designed for 4-mm screws) be used when connecting wires to the optional input terminals.



Crimp-on lug with insulation sleeves (for 4 mm screws)

Wiring Procedure

As shown in the figure on next page, the optional terminal block is located on the rear panel. The optional terminal block is provided on the DX when an option that requires input/output is installed such as the alarm output relay (/A[] option), FAIL/status output relay (/F1 or /F2 option), and remote control function (/R1 option), etc. A terminal cover is screwed in place on the measuring input terminal block. A label indicating the terminal arrangement is affixed to the cover.

1. Turn OFF the DX and remove the terminal cover.
2. Connect the signal wires to the terminals.
3. Replace the terminal cover and fasten it with screws. The proper torque for tightening the screws is 0.6 N-m.

Arrangement of the Optional Terminals

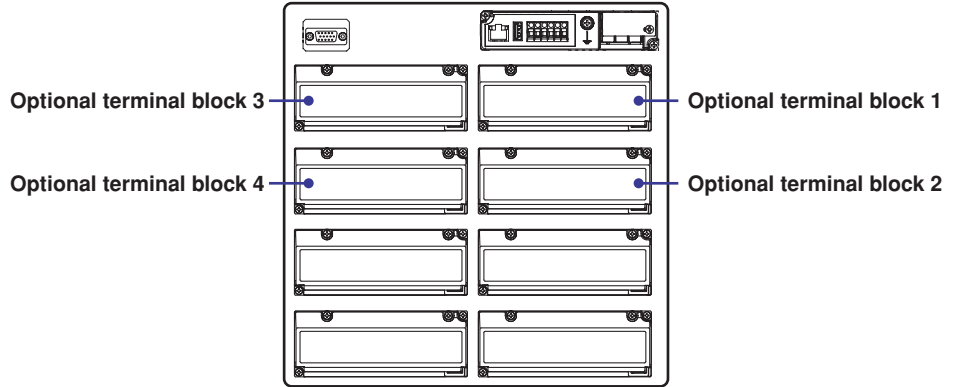

Terminal arrangement of /A1 to /A5, /R1, /F1, /F2, and /PM1 options (terminal block 1)

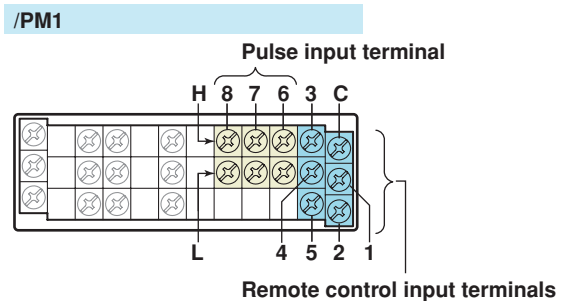
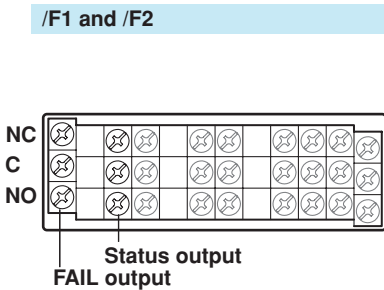
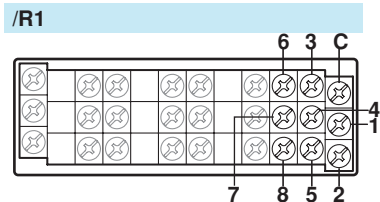
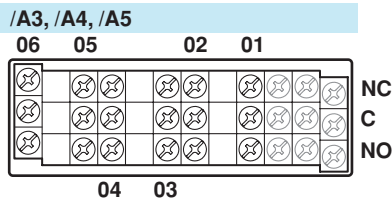
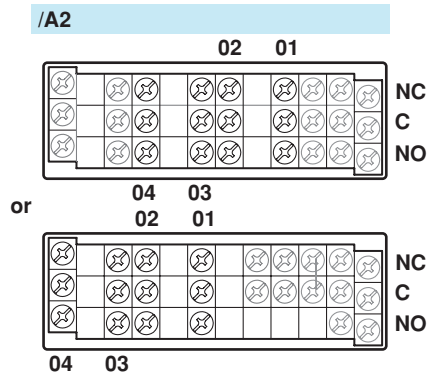
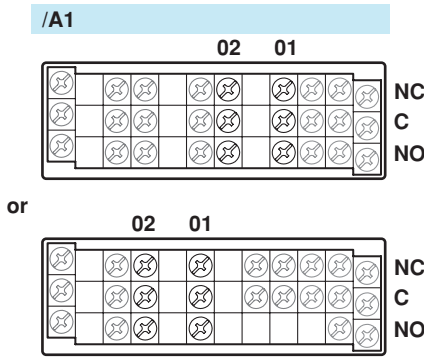

Terminal arrangement of /TPS4 and /TPS8 options (terminal block 3)

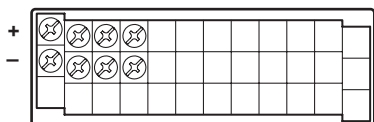

Alarm Output Terminal, FAIL Output Terminal, and Status Output Terminal (/A1, /A2, /A3, /A4, /A5, /F1, and /F2)

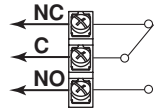

Output format: Relay contact
Contact rating: 250 VAC (50/60 Hz)/3 A, 250 VDC/0.1 A (for resistor load)
Withstand voltage: 1600 VAC at 50/60 Hz for one minute (between output terminals and the ground terminal)

Remote Control Input Terminal (/R1)

- **Relay contact input (voltage-free contact)**
 Contact closed at 200 Ω
 Contact open at 100 kΩ or greater

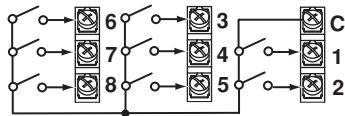

- **Transistor input (open collector)**
 ON voltage: 0.5 V or less (30 mADC)
 Leakage current when turned OFF: 0.25 mA or less

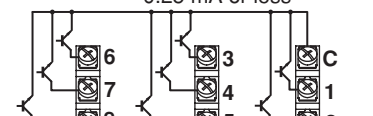

Withstand voltage: 1000 VDC for one minute between input terminals and the ground terminal

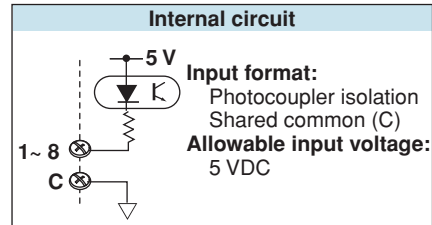

Pulse Input Terminal (/PM1)

- **Relay contact input (voltage-free contact)**
 Contact closed at 200 Ω
 Contact open at 100 kΩ or greater

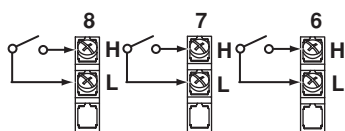

- **Transistor input (open collector)**
 ON voltage: 0.5 V or less (30 mADC)
 Leakage current when turned OFF: 0.25 mA or less

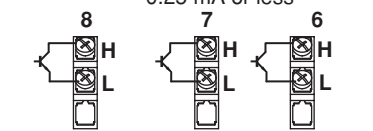

Withstand voltage: 1000 VDC for one minute between input terminals and the ground terminal

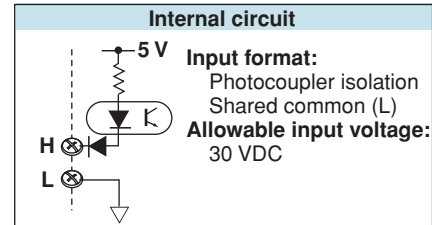

24 VDC Transmitter Power Supply Output Terminal (/TPS4 and /TPS8)

Connect the DX to the transmitter as shown below.

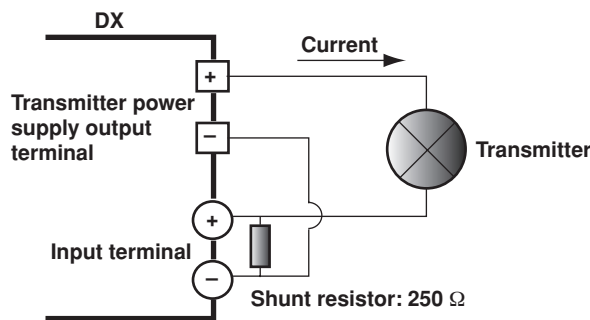

Note

To reduce noise, use a shielded cable for wiring. Connect the shield to the functional ground terminal or the ground terminal of the DX.

Serial Interface

Connecting to the RS-232 Connector (/C2)

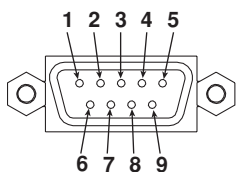

- 2 RD (Received Data): Received data from the PC. Input signal to the DX.
- 3 SD (Send Data): Transmitted data to the PC. Output signal from the DX.
- 5 SG (Signal Ground): Signal ground.
- 7 RS (Request to Send): Handshaking signal when receiving data from the PC. Output signal from the DX.
- 8 CS (Clear to Send): Handshaking signal when transmitting data to the PC. Input signal to the DX.

* Pins 1, 4, 6, and 9 are not used.

Connecting to the RS-422A/485 (/C3)

Four-wire system

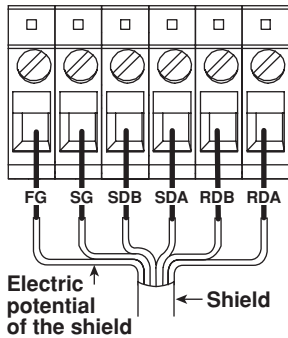

Two-wire system

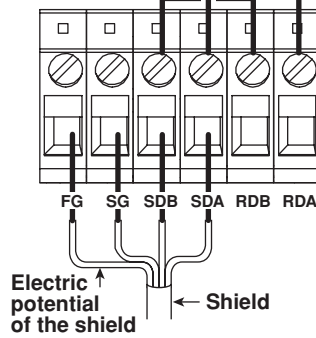

- FG (Frame Ground)** Frame ground of the DX.
- SG (Signal Ground)** Signal ground.
- SDB (Send Data B)** Send data B (+).
- SDA (Send Data A)** Send data A (-).
- RDB (Received Data B)** Receive data B (+).
- RDA (Received Data A)** Receive data A (-).

Recommended length of stripped wire: 9 mm. Recommended tightening torque: 0.4-0.5 Nm

Cable

There are two types of cables available, the four-wire cable and the two-wire cable (used only for the Modbus protocol). The cable should meet the following specifications.

- Type: Shielded twisted pair cable: 3 pairs 24 AWG or more (four-wire),
2 pair 24 AWG or more (two-wire)
- Characteristic impedance: 100 Ω
- Capacitance: 50 pF/m
- Total cable length: Up to 1.2 km

Connecting to the VGA Connector (/D5)



CAUTION

- Connect the cable after turning OFF the DX and the monitor.
- Do not short the VIDEO OUT terminal or apply external voltage to it. If you do, the DX may malfunction.

VGA Output Terminal

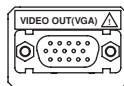

The DX display can be output to a monitor through the RGB output. Connectable monitors are VGA monitors or multi-sync monitors capable of displaying VGA.

Specifications of the VGA Output Terminal

Pin No.	Signal Name	Specifications
1	Red	0.7 Vp-p
2	Green	0.7 Vp-p
3	Blue	0.7 Vp-p
4	-	
5	-	
6	GND	
7	GND	
8	GND	
9	-	
10	GND	
11	-	
12	-	
13	Horizontal sync signal	Approx. 31.5 kHz, TTL negative logic
14	Vertical sync signal	Approx. 60 Hz, TTL negative logic
15	-	

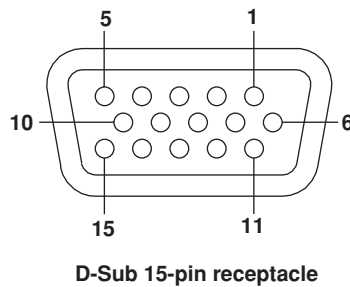

D-Sub 15-pin receptacle

Connecting to the Monitor

1. Turn OFF the DX and the monitor.
2. Connect the DX and the monitor using an analog RGB cable.
3. Turn ON the power to both the DX and the monitor. The DX screen is displayed on the monitor.

Note

- When the DX is turned ON, a VGA signal is always output from the VIDEO OUT terminal.
- The monitor screen may flicker if the DX or another instrument is brought close to the monitor.
- The edge of the screen may drop out depending on the monitor type.

Connecting to the USB Port (/USB1)

The USB port complies with Rev. 1.1.

Front

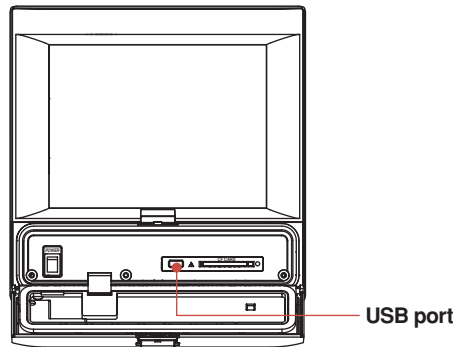

Rear

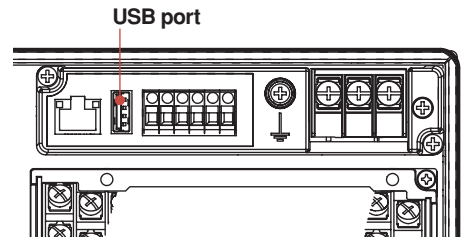

Connecting to the Ethernet Port

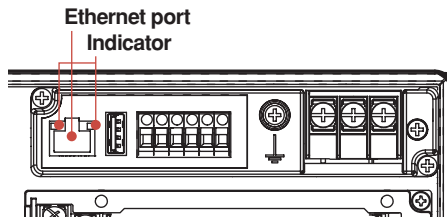

Checking the Connection/Communication Status

The connection status of the Ethernet interface can be confirmed with the indicator that is located to the upper right of the Ethernet connector of the DX.

Indicator	Connection Status of the Ethernet Interface
Illuminated (green)	The Ethernet interface is electrically connected.
Blinking (red)	Transmitting data.
Off	The Ethernet interface is not electrically connected.

Checking the Connection on the DX Display

- **Checking the Connection at the status indication section of the DX display.**
You can check the connection status of the Ethernet interface on the Ethernet Link indicator located on the right side of the status indication section of the basic setting mode display. The basic setting menu appears by pressing **MENU** to display the setting menu followed by **FUNC** for approximately 3 s.
- **Checking the Connection Status in the Display Section in the Upper Right Corner of the Communication Log Display of the DX**
You can check the connection status of the Ethernet interface on the Link indicator on the display section in the upper right corner of the communication log display.

Indicator	Connection Status of the Ethernet Interface
Illuminated (green)	The Ethernet interface is electrically connected.
Off	The Ethernet interface is not electrically connected.

Power Supply Wiring
Panel Mount Type

Precautions to Be Taken While Wiring the Power Supply

This section explains the precautions to be taken on models whose rated supply voltage is 100 to 240 VAC. Make sure to follow the warnings below when wiring the power supply. To prevent electric shock and damage to the DX, observe the following warnings.



WARNING

- To prevent electric shock when wiring, ensure the main power supply is turned OFF.
- To prevent the possibility of fire, use 600 V PVC insulated wire (AWG20 to 16) or an equivalent wire for power wiring.
- Make sure to earth ground the protective earth terminal through a grounding resistance less than 100 Ω before turning ON the power.
- Use crimp-on lug with insulation sleeves (for 4-mm screws) for power supply wires and protective grounding wires.
- To prevent electric shock, make sure to close the transparent cover for the power supply wires.
- Make sure to provide a power switch (double-pole type) on the power supply line in order to separate the DX from the main power supply. Put an indication on this switch as the breaker on the power supply line for the DX and indications of ON and OFF. Switch specifications Steady-state current rating: 1 A or more. Inrush current rating: 60 A or more. Complies with IEC60947-1, 3.
- Connect a fuse (between 2 A and 15 A) to the power line.
- Do not add a switch or fuse to the ground line.

Use a power supply that meets the following conditions:

Item	Condition
Rated supply voltage	100 to 240 VAC
Allowable power supply voltage range	90 to 132/180 to 264 VAC
Rated power supply frequency	50/60 Hz
Allowable power supply frequency range	50/60 Hz ± 2%
Maximum power consumption	74 VA (100 V)/100 VA (240 V)

Note

Do not use a supply voltage in the range 132 to 180 VAC, as this may have adverse effects on the measurement accuracy.

Wiring Procedure

1. Turn OFF the power to the DX and open the transparent power terminal cover.
2. Wire the power cord and the protective ground cord to the power supply terminals. Use ring-tongue crimp-on lugs (designed for 4 mm screws).

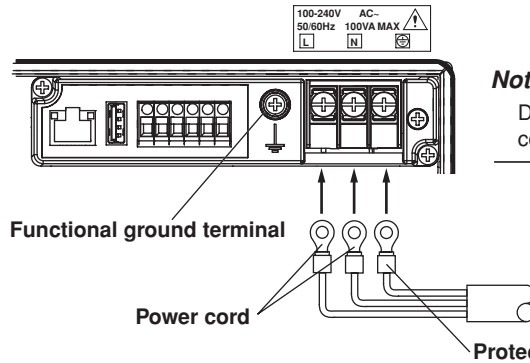

Note

Do not wire the protective grounding cord to the functional ground terminal.

3. Replace the power terminal cover, and fasten it with screws.

Desktop Type

Precautions to Be Taken While Connecting the Power Supply

Make sure to follow the warnings below when connecting the power supply. To prevent electric shock and damage to the DX, observe the following warnings.



WARNING

- Before connecting the power cord, ensure that the source voltage matches the rated supply voltage of the DX and that it is within the maximum rated voltage range of the provided power cord.
- Connect the power cord after checking that the power switch of the DX is turned OFF.
- To prevent electric shock or fire, be sure to use the power cord supplied by YOKOGAWA.
- Make sure to perform protective earth grounding to prevent electric shock. Connect the power cord of the desktop type to a three-prong power outlet with a protective earth terminal.
- Do not use an extension cord without protective earth ground. Otherwise, the protection function will be compromised.

Use a power supply that meets the following conditions:

Item	Condition
Rated supply voltage	100 to 240 VAC
Allowable power supply voltage range	90 to 132, 180 to 264 VAC
Rated power supply frequency	50/60 Hz
Allowable power supply frequency range	50/60 Hz \pm 2%
Maximum power consumption	74 VA (100V) and 100 VA (240 V)

Note

Do not use a supply voltage in the range 132 to 180 VAC, as this may have adverse effects on the measurement accuracy.

Connection Procedure

1. Check that the power switch is OFF.
2. Connect the power cord plug to the power connector on the rear panel. (Use the power cord that comes with the package.)

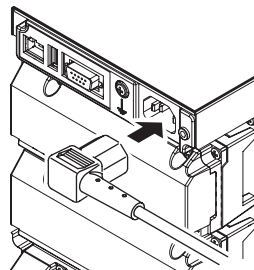

3. Check that the power outlet meets the conditions given in the table above and that the supply voltage is within the maximum rated voltage range of the power cord that comes with the package. Then, connect the other end of the power cord to the power outlet. The AC outlet must be of a three-prong type with a protective earth ground.

Recommended Replacement Periods for Worn Parts Maintenance

To preserve the reliability of the DX and to use the DX in a good condition for an extended time, it is recommended that periodic replacements be made on parts. The following table shows the recommended replacement period for expendable parts. The replacement period shown here applies when the recorder is used under standard operating conditions. For the actual replacement period, consider the actual conditions of use. Replacement of parts will be carried out by a YOKOGAWA engineer or an engineer certified by YOKOGAWA. Contact your nearest YOKOGAWA dealer when such replacement is necessary.

Item	Replacement period	Name	Part No.	Quantity Used	Notes
LCD	5 years	Backlight module	B9968PA	1	
Battery	10 years	Lithium battery	B9900BR	1	
Dust and water proof strip	5 years	Rubber strip	B8706FY	1	
	5 years	Key case assembly	B8706BM	1	English specifications
	5 years	Key case assembly	B8706BY	1	Japanese specifications
Aluminum electrolytic capacitor	5 years*	Power supply assembly	—	1	
	5 years*	AD assembly	Depends on the model		

* Replacement period at the upper limit of the normal operating temperature (50°C)
 The replacement period varies depending on the operating temperature and the specifications of the DX.
 If the operating temperature is 30°C, it may be possible to use the parts for more than 10 years.

Note

- The LCD replacement period indicates the half life of the brightness when the brightness is set to the factory default setting. The half life is shortened as the brightness is set higher. The deterioration of brightness varies depending on the condition of use, and its determination is subjective. Consider these facts for determining the actual replacement period.
- The color of the LCD may become yellowish as time elapses. The discoloration tends to progress faster as the brightness is set higher.

Setup Items and Default Values

The setup items and the default values in the setting mode are listed below. Enter the settings that you are using in the Setting column for your convenience.

Setting mode menu

Setting mode menu	
Date/Time	Page 64
Meas channel	Page 64 to 66
Math channel	Page 67 and 68*
Ext. channel	Page 69*
Display	Page 70
Group set. Trip line	Page 70
Message	Page 70
Timer, Event action	Page 71
Data save	Page 72
Save/Load	Page 72
Menu customize	Page 72

*: Options

Basic setting mode menu

Basic Setting Mode	
Setting menu	
Alarm	Page 73
A/D, Memory	Page 73
Burnout, RJC	Page 73
Environment	Page 73 and 74
Keylock	Page 74 ²
Login	Page 75 ²
Report	Page 75 ¹
Time settings	Page 75
Load settings, Initialize	Page 75
Communication (Ethernet)	Page 76 and 78
Communication (Serial)	Page 78 ¹
Status relay	Page 79
End	Page 79

1: Options

2: Displayed when the function is enabled in the **Environment** settings.

Setup Items in Setting Mode and Their Default Values

Date/Time > Time settings

Setup Item	Selectable Range or Selections	Default Value	Setting
Time set	–	–	

Date/Time > Daylight Saving Time

Setup Item	Selectable Range or Selections	Default Value	Setting
Use/Not	Use/Not	Not	
Start time > Month	JAN/FEB/MAR/APR/MAY/JUN/JUL/AUG/SEP/OCT/NOV/DEC	APR	
Start time > Day order	1st/2nd/3rd/4th/Last	1st	
Start time > Day of the week	SUN/MON/TUE/WED/THU/FRI/SAT	SUN	
Start time > Hour of the day	Numerical value	2	
End time > Month	JAN/FEB/MAR/APR/MAY/JUN/JUL/AUG/SEP/OCT/NOV/DEC	OCT	
End time > Day order	1st/2nd/3rd/4th/Last	Last	
End time > Day of the week	SUN/MON/TUE/WED/THU/FRI/SAT	SUN	
End time > Hour of the day	Numerical value	1	

Meas channel > Range, Alarm

Setup Item	Selectable Range or Selections	Default Value	Setting
First-CH, Last-CH Range > Mode	Channel number Skip/Volt/TC/RTD/Scale/Delta/DI/ 1-5V/Sqrt	Volt	
Mode=Volt			
Range	20mV/60mV/200mV/2V/6V/20V/50V	2V	
Span Lower	Depends on the range.	–	
Span Upper	Depends on the range.	–	
Mode=TC			
Range	R/S/B/K/E/J/T/N/W/L/U/WRe	R	
Span Lower	Depends on the range.	–	
Span Upper	Depends on the range.	–	
Mode=RTD			
Range	Pt/JPt	Pt	
Span Lower	Depends on the range.	–	
Span Upper	Depends on the range.	–	
Mode=Scale			
Type	Volt/TC/RTD/DI	Volt	
Range	Depends on the type.	–	
Span Lower	Depends on the range.	–	
Span Upper	Depends on the range.	–	
Scale Lower	–30000 to 30000, decimal position: 0 to 4	0.00	
Scale Upper	–30000 to 30000, decimal position: 0 to 4	200.00	
Unit	6 characters or less		
Mode=Delta			
Type	Volt/TC/RTD/DI	Volt	
Range	Depends on the type.	–	
Span Lower	Depends on the range.	–	
Span Upper	Depends on the range.	–	
Ref.CH	Meas channel number	–	
Mode=DI			
Range	Level/Cont	Level	
Span Lower	0, 1	0	
Span Upper	0, 1	1	

Setup Item	Selectable Range or Selections	Default Value	Setting
Mode=1-5V			
Range	1-5V	1-5V	
Span Lower	0.800 to 5.200	1.000	
Span Upper	0.800 to 5.200	5.000	
Scale Lower	-30000 to 30000, decimal position :0 to 4	0.00	
Scale Upper	-30000 to 30000, decimal position :0 to 4	200.00	
Unit	6 characters or less	-	
Low-cut	On/Off	Off	
Mode=Sqrt			
Range	20mV/60mV/200mV/2V/6V/20V/50V		
Span Lower	Depends on the range.	-	
Span Upper	Depends on the range.	-	
Scale Lower	-30000 to 30000, decimal position: 0 to 4	0.00	
Scale Upper	-30000 to 30000, decimal position: 0 to 4	200.00	
Unit	6 characters or less	-	
Low-cut	On/Off	Off	
Low-cut value	0.0 to 5.0	0.5	
Alarm			
1, 2, 3, 4	On/Off	Off	
Type	H:High/L:Low/h:delta H/l:delta L/R:rate H/ r:rate L/T:delayH/t:delayL	H	
Value	Numerical value	-	
Relay	On/Off	Off	
Number	I01/.../I06, I11/.../I16, I21/.../I26, I31/.../I36 (Depends on the model.) S01/S02/S03/.../S29/S30	I01	
Detect	On/Off	On	

Meas channel > Tag, Memory sample, Alarm delay

Setup Item	Selectable Range or Selections	Default Value	Setting
First-CH, Last-CH	Channel number	-	
Tag > Tag	16 characters or less	-	
Memory sample > On/Off	On/Off	On	
Alarm delay > Time	1 to 3600	10	

Meas channel > Moving average

Setup Item	Selectable Range or Selections	Default Value	Setting
First-CH, Last-CH	Channel number	-	
Moving average > On/Off	On/Off	Off	
Moving average > Count	2 to 400	2	

Meas channel > Color

Setup Item	Selectable Range or Selections	Default Value	Setting
Group of channel	001-010, etc	Depends on the model.	
Color	Red/Green/Blue/B.violet/Brown/Orange/ Y.green/Lightblue/Violet/Graly/Lime/Cyan/ Darkblue/Yellow/Lightgray/Purple/Black/Pink/ L.brown/L.green/Darkgray/Olive/DarkCyan/ S.green (24 colors)	Red to Gray	

Setup Items and Default Values

Meas channel > Zone, Scale, Bar graph

Setup Item	Selectable Range or Selections	Default Value	Setting
First-CH, Last-CH	Channel number	–	
Zone > Lower	0 to 95	0	
Zone > Upper	5 to 100	100	
Scale > Position	Off/1/2/3/4/5/6/7/8/9/10	1	
Scale > Division	4/5/6/7/8/9/10/11/12/C10	10	
Bar graph > Base position	Normal/Center	Normal	
Bar graph > Division	4/5/6/7/8/9/10/11/12	10	

Meas channel > Partial

Setup Item	Selectable Range or Selections	Default Value	Setting
First-CH, Last-CH	Channel number	–	
On/Off	On/Off	Off	
Expand	1 to 99%	50	
Boundary	Span Lower+1digit to Span Upper-1digit	0.0000	

Meas channel > Alarm mark, Color scale band

Setup Item	Selectable Range or Selections	Default Value	Setting
First-CH, Last-CH	Channel number	–	
Alarm mark > Mark kind	Alarm/Fixed	Alarm	
Alarm mark > Indicate on Scale	On/Off	Off	
Alarm mark > Alarm mark color > Alarm 1	Red/Green/.../S.green (24 colors)	Red	
Alarm mark > Alarm mark color > Alarm 2	Same as Alarm 1	Orange	
Alarm mark > Alarm mark color > Alarm 3	Same as Alarm 1	Orange	
Alarm mark > Alarm mark color > Alarm 4	Same as Alarm 1	Red	
Color scale band > Band area	Off/In/Out	Off	
Color scale band > Color	Red/Green/.../S.green (24 colors)	Lime	
Color scale band > Display position > Lower	Measuring range	0.0000	
Color scale band > Display position > Upper	Measuring range	0.0100	

Meas channel > Calibration correction

Setup Item	Selectable Range or Selections	Default Value	Setting
First-CH, Last-CH	Channel number	–	
Number of set points	Off/2/3/4/5/6/7/8/9/10/11/12/13/14/15/16	Off	
1 to n > MES val	Value in the measuring range/measured value	–	
1 to n > True val	Measuring range	–	

Math channel > Calculation expression, Alarm

Setup Item	Selectable Range or Selections	Default Value	Setting
First-CH, Last-CH	Channel number	–	
Math range > Math On/Off	On/Off	Off	
Math range > Calculation expression	120 characters or less	–	
Math range > Span Lower	–9999999 to 99999999, decimal position: 0 to 4	–	
Math range > Span Upper	–9999999 to 99999999, decimal position: 0 to 4	–	
Math range > Unit	6 characters or less	–	
Math alarm			
1, 2, 3, 4	On/Off	Off	
Type	H:High/L:Low/T:delayH/t:delayL	–	
Value	Numerical value	–	
Relay On/Off	On/Off	Off	
Number	I01/.../I06, I11/.../I16, I21/.../I26, I31/.../I36 (Depends on the model.) S01/S02/S03/.../S29/S30	I01	
Detect	On/Off	On	

Math channel > Constant

Setup Item	Selectable Range or Selections	Default Value	Setting
Number of constant	K01 to K60	K01	
Value	–9.9999E+29 to –1.0000E–30, 0, 1.0000E–30 to –9.9999E+29	1	

Math channel > Tag, Memory sample, Alarm delay

Setup Item	Selectable Range or Selections	Default Value	Setting
First-CH, Last-CH	Channel number	–	
Tag > Tag	16 characters or less	–	
Memory sample > On/Off	On/Off	On	
Alarm delay > Time	1 to 3600	10	

Math channel > TLOG, Rolling average

Setup Item	Selectable Range or Selections	Default Value	Setting
TLOG > Timer No.	1/2/3/4	1	
TLOG > Sum scale	Off, /s, /min, /h	Off	
TLOG > Reset	On/Off	Off	
Rolling average > On/Off	On/Off	Off	
Rolling average > Interval	1s/2s/3s/4s/5s/6s/10s/12s/15s/20s/30s/ 1min/2min/3min/4min/5min/6min/10min/12min/ 15min/20min/30min/1h	10s	
Rolling average > Number of samples	1 to 1500	1	

Math channel > Color

Setup Item	Selectable Range or Selections	Default Value	Setting
Group of channel	101-110, etc	Depends on the model.	
Color	Red/Green/.../S.green (24 colors)	Red to Gray	

Math channel > Zone, Scale, Bar graph

Same as Meas channel.

Setup Items and Default Values

Math channel > Partial

Setup Item	Selectable Range or Selections	Default Value	Setting
First-CH, Last-CH	Channel number	–	
On/Off	On/Off	Off	
Expand	1 to 99%	50	
Boundary	Span Lower+1digit to Span Upper–1digit	0.00	

Math channel > Alarm mark, Color scale band

Setup Item	Selectable Range or Selections	Default Value	Setting
First-CH, Last-CH	Channel number	–	
Alarm mark > Mark kind	Alarm/Fixed	Alarm	
Alarm mark > Indicate on Scale	On/Off	Off	
Alarm mark > Alarm mark color > Alarm 1	Red/Green/.../S.green (24 colors)	Red	
Alarm mark > Alarm mark color > Alarm 2	Same as Alarm 1	Orange	
Alarm mark > Alarm mark color > Alarm 3	Same as Alarm 1	Orange	
Alarm mark > Alarm mark color > Alarm 4	Same as Alarm 1	Red	
Color scale band > Band area	Off/In/Out	Off	
Color scale band > Color	Red/Green/.../S.green (24 colors)	Lime	
Color scale band > Display position > Lower	Measuring range	0.00	
Color scale band > Display position > Upper	Measuring range	1.00	

Math channel > Math start action

Setup Item	Selectable Range or Selections	Default Value	Setting
Math start action > Math start	Off/Start/Rst+St	Start	

Ext. channel > Range, Alarm

Setup Item	Selectable Range or Selections	Default Value	Setting
First-CH, Last-CH	Channel number	–	
Ext. range > On/Off	Off	Off	
Ext. range > Span Lower	–30000 to 30000, decimal position: 0 to 4	–200.00	
Ext. range > Span Upper	–30000 to 30000, decimal position: 0 to 4	200.000	
Ext. range > Unit	6 characters or less	–	
Ext. alarm			
1, 2, 3, 4	On/Off	Off	
Type	H:High/L:Low/T:delayH/t:delayL	–	
Value	Numerical value	–	
Relay On/Off	On/Off	Off	
Number	I01/.../I06, I11/.../I16, I21/.../I26, I31/.../I36 (Depends on the model.)	I01	
Detect	S01/S02/S03/.../S29/S30	On	

Ext. channel > Tag, Memory sample, Alarm delay

Setup Item	Selectable Range or Selections	Default Value	Setting
First-CH, Last-CH	Channel number	–	
Tag > Tag	16 characters or less	–	
Memory sample > On/Off	On/Off	On	
Alarm delay > Time	1 to 3600	10	

Ext. channel > Color

Setup Item	Selectable Range or Selections	Default Value	Setting
Group of channel	201-210/211-220/221-230/.../421-430/ 431-440	201-210	
Color	Red/Green/.../S.green (24 colors)	Red to Gray	

Ext. channel > Zone, Scale, Bar graph

Same as Meas channel.

Ext. channel > Partial, Alarm mark, Color scale band

Same as Math channel.

Setup Items and Default Values

Display > Trend (Circular)/Save interval

Setup Item	Selectable Range or Selections	Default Value	Setting
Trend/Save interval			
Trend interval [/div]	15s/30s/1min/2min/5min/10min/15min/20min/ 30min/1h/2h/4h/10h	1min	
Save interval	10min to 31day (Depends on the trend interval.)	1h	
Second interval [/div]	15s/30s/1min/2min/5min/10min/15min/20min/ 30min/1h/2h/4h/10h	1min	
Circular/Save interval			
Time per revolution [/rev]	20min/30min/1h/2h/6h/8h/12h/16h/1day/ 2day/1week/2week/4week	1day	
Save interval	10min to 31day (Depends on the time per revolution.)	1h	
Offset time	Off/1h to 23h (Depends on the time per revolution.)	Off	

Display > Trend (Circular), Bar graph, LCD, Monitor

Setup Item	Selectable Range or Selections	Default Value	Setting
Trend			
Trend > Direction	Horizontal/Vertical/Wide/Split	Horizontal	
Trend > Trend clear	On/Off	Off	
Trend > Message direction	Horizontal/Vertical	Horizontal	
Trend > Scale > Digit	Normal/Fine	Normal	
Trend > Scale > Value indicator	Mark/Bargraph	Mark	
Trend > Trend line	1/2/3	2	
Trend > Grid	Auto/4/5/6/7/8/9/10/11/12	Auto	
Circular			
Circular > Full circle action	Allclear/Divclear	Allclear	
Circular > Trend line	1/2/3	2	
Circular > Grid	Auto/4/5/6/7/8/9/10/11/12	Auto	
Bar graph > Direction	Horizontal/Vertical	Vertical	
LCD > Brightness	1/2/3/4/5/6	2	
LCD > Backlight saver > Mode	Off/Dimmer/Timeoff	Off	
LCD > Backlight saver > Saver time	1min/2min/5min/10min/30min/1h	1h	
LCD > Backlight saver > Restore	Key, Key+Alarm	Key+Alarm	
Monitor > Background > Display	White/Black	White	
Monitor > Background > Historical trend	White/Cream/Black/Lightgray	Black	
Monitor > Scroll time	5s/10s/20s/30s/1min	10s	
Monitor > Jump default display	Off/1min/2min/5min/10min/20min/30min/1h	Off	

Group set, Trip line

Setup Item	Selectable Range or Selections	Default Value	Setting
Group number	1/2/3/.../35/36	1	
Group set > On/Off	On/Off	Depends on the model.	
Group set > Group name	GROUP1 to GROUP36/16 characters or less	GROUP1 etc.	
Group set > CH set	39 characters or less	Depends on the model.	
Trip line > 1	On/Off	Off	
Trip line > 2	On/Off	Off	
Trip line > 3	On/Off	Off	
Trip line > 4	On/Off	Off	
Trip line > Position	0 to 100	50	
Trip line > Color	Red/Green/.../S.green (24 colors)	1:Red, 2:Green 3:Blue, 4:Yellow	
Trip line > Line width	1/2/3	2	

Message

Setup Item	Selectable Range or Selections	Default Value	Setting
Message No.	1-10/11-20/21-30/31-40/41-50/51-60/ 61-70/71-80/81-90/91-100	1-10	
Message 1 to 100	32 characters or less	–	

Timer, Event action > Timer

Setup Item	Selectable Range or Selections	Default Value	Setting
Timer No.	1/2/3/4	1	
Mode	Off/Relative/Absolute	Off	
Relative > Interval	00:01 to 24:00	01:00	
Relative > Reset at Math Start	On/Off	On	
Absolute > Interval	1min/2min/3min/4min/5min/6min/10min/ 12min/15min/20min/30min/1h/2h/3h/4h/ 6h/8h/12h/24h	1h	
Absolute > Ref.time	0 to 23	0:00	

Timer, Event action > Match time timer

Setup Item	Selectable Range or Selections	Default Value	Setting
Timer number	1/2/3/4	1	
Kind	Off/Day/Week/Month	Off	
Day	1 to 28	1	
Day of the week	SUN/MON/TUE/WED/THU/FRI/SAT	SUN	
Hour	00:00 to 23:59	00:00	
Timer action	Single/Repeat	Repeat	

Timer, Event action > Event action

Setup Item	Selectable Range or Selections	Default Value	Setting
Logic box number	1/2/3/.../39/40	1	
Event	None/Remote/Relay/Switch/Timer/ Matchtime/Alarm/UserKey	None	
Remote > Remote number	1/2/3/4/5/6/7/8	1	
Relay > Relay number	I01/.../I06, I11/.../I16, I21/.../I26, I31/.../I36 (Depends on the model.)	I01	
Switch > Switch No.	S01/S02/S03/.../S29/S30	S01	
Timer > Timer No.	1/2/3/4	1	
MatchTimeTimer > Match Time Timer No.	1/2/3/4	1	
Action	Memory/Start/Stop/Trigger/AlarmACK/ Math/MathStart/MathStop/Math rst/SaveDisp/ SaveEvent/Message/Snapshot/Rate1/ 2/M.sample/TimerRst/Group/Flag/ PnlLoad/Time adj	Group	
Message > Message No.	1 to 100	1	
Message > Write to	All/Select	All	
Message > Group number	1/2/3/.../35/36	1	
Group > Group number	1/2/3/.../35/36	1	
Flag > Flag number	1/2/3/4/5/6/7/8	1	
TimerRst > Timer No.	1/2/3/4	1	
PnlLoad > Setting file number	1/2/3	1	

Setup Items and Default Values

Data save > File header, Data file name

Setup Item	Selectable Range or Selections	Default Value	Setting
File header > Characters	50 characters or less	–	
Data file name > Structure	Date/Serial/Batch	Date	
Data file name > Identified strings	16 characters or less	–	

Data save > Save directory

Setup Item	Selectable Range or Selections	Default Value	Setting
Directory name	32 characters or less	DATA0	

Data save > Event data

Setup Item	Selectable Range or Selections	Default Value	Setting
Sample rate	25ms/125ms/250ms/500ms/1s/2s/5s/10s/ 30s/60s/120s/300s/600s (Depends on the model.)	1s	
Mode	Free/Single/Repeat	Free	
Data length	10min to 31day (Depends on the sample rate.)	1h	
Pre-trigger	0/5/25/50/75/95/100	0	
Trigger signal > Key	On/Off	On	
Trigger signal > Event-Action	On/Off	Off	

Data save > Manual sample

Setup Item	Selectable Range or Selections	Default Value	Setting
Manual sample number	001 to 120	001	
On/Off	On/Off	On	
Channel	Channel number	001	

Data save > Batch text

Setup Item	Selectable Range or Selections	Default Value	Setting
Text field number	1/2/3/4/5/6/7/8	1	
Text field > Title of field	20 characters or less	–	
Text field > Characters	30 characters or less	–	

Save/Load

Setup Item	Selectable Range or Selections	Default Value	Setting
Load display data > Kind	CF/USB	CF	
Load event data > Kind	CF/USB	CF	
Load settings > Kind	CF/USB	CF	
Save settings > Kind	CF/USB	CF	
Save settings > File name	32 characters or less	–	
File list/delete > Kind	CF/USB	CF	
Format > Kind	CF/USB	CF	
Format > Volume name	11 characters or less	–	

Menu customize

Setup Item	Selectable Range or Selections	Default Value	Setting
Function menu	Select/Hide/View/Transfer	–	
Display menu	Separate/Select/Hide/View/Transfer	–	

Setup Items in Basic Setting Mode and Their Default Values

Alarm

Setup Item	Selectable Range or Selections	Default Value	Setting
Basic setting			
Reflash	On/Off	Off	
Rate of change > Decrease	1 to 32	1	
Rate of change > Increase	1 to 32	1	
Indicator	Hold/Nonhold	Nonhold	
Hysteresis			
Meas CH > High/Low	0.0 to 5.0	0.5	
Meas CH > Delta High/Low	0.0 to 5.0	0.0	
Math CH > High/Low	0.0 to 5.0	0.0	
Ext. CH > High/Low	0.0 to 5.0	0.0	
Switch, Relay			
Internal Switch > AND	None/S01/S01-S02/.../S01-S29/S01-S30	None	
Relay > AND	None/I01/I01-I02/.../I01-I35/I01-I36	None	
Relay > Action	Energize/De_energ	Energize	
Relay > Hold	Hold/Nonehold	Nonhold	

A/D, Memory

Setup Item	Selectable Range or Selections	Default Value	Setting
Scan interval > Scan mode			
Normal > Scan interval	Normal/Fast	Normal	
	125ms/250ms(DX2004, DX2008)	125ms	
	1s/2s/5s(DX2010, DX2020, DX2030, DX2040, DX2048)	1s	
Normal > A/D integrate	Auto/50Hz/60Hz/100ms	Auto	
Fast > Scan interval	25ms (DX2004, DX2008)	25ms	
	125ms (DX2010, DX2020, DX2030, DX2040, DX2048)	125ms	
Fast > A/D integrate	600Hz	600Hz	
Memory > Data kind	Display/E+D/Event	Display	

Burnout, RJC

Setup Item	Selectable Range or Selections	Default Value	Setting
First-CH, Last-CH	Channel number	–	
Burnout set > Mode	Off/Up/Down	Off	
RJC > Mode	Internal/External	Internal	
RJC > Volt	–20000 to 20000 μ V	0	

Environment > Operating environment

Setup Item	Selectable Range or Selections	Default Value	Setting
Tag/Channel	Tag/Channel	Tag	
Language	English/Japanese/Chinese	English	
Remote Controller ID	Off/0/1/.../30/31	Off	
Temperature	C/F	C	

Environment > View, Message, Input, Alarm

Setup Item	Selectable Range or Selections	Default Value	Setting
View > Trend type	T-Y/Circular	T-Y	
View > Partial	On/Off	Off	
View > Trend rate switching	On/Off	Off	
Message > Write group	Common/Separate	Common	
Message > Power-fail message	On/Off	Off	
Message > Change message	On/Off	Off	
Input > Value on over-range	Free/Over	Over	
Alarm > No logging	On/Off	Off	

Setup Items and Default Values

Environment > Security, Media save, Batch

Setup Item	Selectable Range or Selections	Default Value	Setting
Security > Key	Off/Login/Keylock	Off	
Security > Communication	Off/Login	Off	
Save > Auto save	On/Off	On	
Batch > On/Off	On/Off	Off	
Batch > Lot-No. digit	Off/4/6/8	6	
Batch > Auto increment	On/Off	On	

Environment > Service port

Setup Item	Selectable Range or Selections	Default Value	Setting
FTP	0 to 65535	21	
HTTP	0 to 65535	80	
SNTP	0 to 65535	123	
Modbus	0 to 65535	502	

Environment > Math, Report

Setup Item	Selectable Range or Selections	Default Value	Setting
Math > Value on Error	+Over/-Over	+Over	
Math > Value on Overflow > SUM, AVE	Error/Skip/Limit	Skip	
Math > Value on Overflow > MAX, MIN, P-P	Over/Skip	Over	
Report > Report select > 1	Max/Min/Ave/Sum/Inst	Ave	
Report > Report select > 2	Off/Max/Min/Ave/Sum/Inst	Max	
Report > Report select > 3	Off/Max/Min/Ave/Sum/Inst	Min	
Report > Report select > 4	Off/Max/Min/Ave/Sum/Inst	Sum	
Report > File type	Separate/Combine	Separate	

Keylock

Setup Item	Selectable Range or Selections	Default Value	Setting
Password	8 characters or less	-	
Key action > START	Free/Lock	Free	
Key action > STOP	Free/Lock	Free	
Key action > MENU	Free/Lock	Free	
Key action > USER	Free/Lock	Free	
Key action > DISP/ENTER	Free/Lock	Free	
Key action > FAVORITE	Free/Lock	Free	
Media/USB > External media	Free/Lock	Free	
Action of Function > AlarmACK	Free/Lock	Free	
Action of Function > Message/Batch	Free/Lock	Free	
Action of Function > Math	Free/Lock	Free	
Action of Function > Data save	Free/Lock	Free	
Action of Function > E-mail/FTP	Free/Lock	Free	
Action of Function > Time set	Free/Lock	Free	
Action of Function > Display Function	Free/Lock	Free	

Login

Setup Item	Selectable Range or Selections	Default Value	Setting
User basic settings > Auto logout	Off/1min/2min/5min/10min	Off	
User basic settings > Operation without Login	Off/Display	Off	
Admin settings > Admin number	1/2/3/4/5	1	
Admin settings > Mode	Off/Key/Comm/Web/Key+Comm	Off	
Admin settings > User name	20 characters or less	Admin1	
Admin settings > Password	8 characters or less	????????	
User settings > User number	1/2/3/.../29/30	1	
User settings > Mode	Off/Key/Comm/Web/Key+Comm	Off	
User settings > User name	20 characters or less	User1	
User settings > Password	8 characters or less	????????	
User settings > Authority of user	Off/1/2/3/4/5/6/7/8/9/10	Off	
Authority of user			
Authority of user	1/2/3/4/5/6/7/8/9/10	1	
Key action > START	Free/Lock	Free	
Key action > STOP	Free/Lock	Free	
Key action > MENU	Free/Lock	Free	
Key action > USER	Free/Lock	Free	
Key action > DISP/ENTER	Free/Lock	Free	
Key action > FAVORITE	Free/Lock	Free	
Media/USB > External media	Free/Lock	Free	
Action of Function > AlarmACK	Free/Lock	Free	
Action of Function > Message/Batch	Free/Lock	Free	
Action of Function > Math	Free/Lock	Free	
Action of Function > Data save	Free/Lock	Free	
Action of Function > E-mail/FTP	Free/Lock	Free	
Action of Function > Time set	Free/Lock	Free	
Action of Function > Display Function	Free/Lock	Free	

Report

Setup Item	Selectable Range or Selections	Default Value	Setting
Basic settings > Report kind	Off/Hour/Day/Hour+Day/Day+Week/Day+Month	Off	
Basic settings > Date	1 to 28	1	
Basic settings > Day of the week (Day+week)	SUN/MON/TUE/WED/THU/FRI/SAT	SUN	
Basic settings > Time (hour)	0 to 23	0:00	
Report settings > Report channel number	R01/R02/R03/.../R59/R60	R01	
Report settings > On/Off	On/Off	On	
Report settings > Channel	Channel number	1	
Report settings > Sum scale	Off, /s, /min, /h, /day	/s	

Time settings

Setup Item	Selectable Range or Selections	Default Value	Setting
Time settings > Time zone (HHMM)	-1300 to 1300	900	
Time settings > Time deviation limit	Off/10s/20s/30s/1min/2min/3min/4min/5min	30s	
Time settings > Date format	Y/M/D, M/D/Y, D/M/Y, D.M.Y	Y/M/D	

Load settings, Initialize

Setup Item	Selectable Range or Selections	Default Value	Setting
Load settings > Kind	CF/USB	CF	
Initialize > Kind	Clear 1/Clear 2/Clear 3	Clear 3	
Media eject	CF/USB	-	

Setup Items and Default Values

Communication (Ethernet) > IP-address

Setup Item	Selectable Range or Selections	Default Value	Setting
DHCP	Use/Not	Not	
DNS accession	Use/Not	Use	
Host-name register	Use/Not	Use	
Fixed IP-address > IP-address	0.0.0.0 to 255.255.255.255	0.0.0.0	
Fixed IP-address > Subnet mask	0.0.0.0 to 255.255.255.255	0.0.0.0	
Fixed IP-address > Default gateway	0.0.0.0 to 255.255.255.255	0.0.0.0	

Communication (Ethernet) > Host settings

Setup Item	Selectable Range or Selections	Default Value	Setting
Host name	64 characters or less	–	
Domain name	64 characters or less	–	

Communication (Ethernet) > DNS settings

Setup Item	Selectable Range or Selections	Default Value	Setting
Server search order > Primary	0.0.0.0 to 255.255.255.255	0.0.0.0	
Server search order > Secondary	0.0.0.0 to 255.255.255.255	0.0.0.0	
Domain suffix search order > Primary	64 characters or less	–	
Domain suffix search order > Secondary	64 characters or less	–	

Communication (Ethernet) > Keep alive, Application time out

Setup Item	Selectable Range or Selections	Default Value	Setting
Keep alive	On/Off	On	
Application time out > On/Off	On/Off	Off	
Application time out > Time	1 to 120 (min)	1	

Communication(Ethernet) > Server

Setup Item	Selectable Range or Selections	Default Value	Setting
FTP	Use/Not	Not	
Web	Use/Not	Not	
SNTP	Use/Not	Not	
Modbus	Use/Not	Not	

Communication (Ethernet) > Web page

Setup Item	Selectable Range or Selections	Default Value	Setting
Page type	Operator/Monitor	Operator	
Page type=Operator			
Web page > On/Off	On/Off	Off	
Web page > Access control	Off/Admin	Off	
Web page > Command	Use/Not	Not	
Page type=Monitor			
Web page > On/Off	On/Off	Off	
Web page > Access control	Off/Admin/User	Off	

Communication (Ethernet) > E-Mail

Setup Item	Selectable Range or Selections	Default Value	Setting
Basic settings			
SMTP server name	64 characters or less	–	
Port number	0 to 65535	25	
Recipient 1	150 characters or less	–	
Recipient 2	150 characters or less	–	
Sender	64 characters or less	–	
Alarm settings			
E-Mail Recipients > Recipient 1	On/Off	Off	
E-Mail Recipients > Recipient 2	On/Off	Off	
Active Alarms > Alarm 1	On/Off	Off	
Active Alarms > Alarm 2	On/Off	Off	
Active Alarms > Alarm 3	On/Off	Off	
Active Alarms > Alarm 4	On/Off	Off	
E-Mail Contents > Include INST	On/Off	Off	
E-Mail Contents > Include source URL	On/Off	Off	
E-Mail Contents > Subject	32 characters or less	Alarm_summary	
E-Mail Contents > Header 1	64 characters or less	–	
E-Mail Contents > Header 2	64 characters or less	–	
Scheduled settings			
E-Mail Recipients and Transmission time > Recipient 1	On/Off	Off	
E-Mail Recipients and Transmission time > Interval	1h/2h/3h/4h/6h/8h/12h/24h	24h	
E-Mail Recipients and Transmission time > Ref.time	00:00 to 23:56	00:00	
E-Mail Recipients and Transmission time > Recipient 2	On/Off	Off	
E-Mail Recipients and Transmission time > Interval	1h/2h/3h/4h/6h/8h/12h/24h	24h	
E-Mail Recipients and Transmission time > Ref.time	00:00 to 23:56	00:00	
E-Mail Contents > Include INST	On/Off	Off	
E-Mail Contents > Include source URL	On/Off	Off	
E-Mail Contents > Subject	32 characters or less	Periodic_data	
E-Mail Contents > Header 1	64 characters or less	–	
E-Mail Contents > Header 2	64 characters or less	–	
System settings			
E-Mail Recipients > Recipient 1	On/Off	Off	
E-Mail Recipients > Recipient 2	On/Off	Off	
E-Mail Contents > Include source URL	On/Off	Off	
E-Mail Contents > Subject	32 characters or less	System_warning	
E-Mail Contents > Header 1	64 characters or less	–	
E-Mail Contents > Header 2	64 characters or less	–	
Report settings			
E-Mail Recipients > Recipient 1	On/Off	Off	
E-Mail Recipients > Recipient 2	On/Off	Off	
E-Mail Contents > Include source URL	On/Off	Off	
E-Mail Contents > Subject	32 characters or less	Report_data	
E-Mail Contents > Header 1	64 characters or less	–	
E-Mail Contents > Header 2	64 characters or less	–	

Setup Items and Default Values

Communication (Ethernet) > FTP client

Setup Item	Selectable Range or Selections	Default Value	Setting
FTP transfer file > Disp&Event data	On/Off	Off	
FTP transfer file > Report	On/Off	Off	
FTP transfer file > Snapshot	On/Off	Off	
FTP connection	Primary/Secondary	Primary	
FTP server name	64 characters or less	–	
Port number	0 to 65535	21	
Login name	32 characters or less	–	
Password	32 characters or less	–	
Account	32 characters or less	–	
PASV mode	On/Off	Off	
Initial path	64 characters or less	–	
SNTP client > Use/Not	Use/Not	Not	
SNTP client > Server name	64 characters or less	–	
SNTP client > Port number	0 to 65535	123	
SNTP client > Access interval	Off/1h/8h/12h/24h	8h	
SNTP client > Access reference time	00:00 to 23:56	00:00	
SNTP client > Access timeout	10s/30s/90s	30s	
SNTP client > Time adjust on Start action	On/Off	Off	

Communication (Ethernet) > Modbus client

Setup Item	Selectable Range or Selections	Default Value	Setting
Basic settings > Read cycle	125ms/250ms/500ms/1s/2s/5s/10s	1s	
Basic settings > Retry interval	Off/1min/2min/5min/10min/20min/30min/1h	2min	
Server number	1-8/9-16	1-8	
Modbus server settings > Port	0 to 65535	502	
Modbus server settings > Modbus server name	64 characters or less	–	
Modbus server settings > Unit	Auto/Fixed	Auto	
Client command number	1-8/9-16	1-8	
Command settings	Off/R/R-M/W/W-M	Off	
Command settings > Client settings > First	Depends on the command type.	–	
Command settings > Client settings > Last	Depends on the command type.	–	
Command settings > Server settings > Server	1/2/3/.../15/16	1	
Command settings > Server settings > Registers	Numerical value	30001	
Command settings > Server settings > Type	INT16/UINT16/INT32_B/INT32_L/UINT32_B/ UINT32_L/FLOAT_B/FLOAT_L	INT16	

Communication (Serial)

Setup Item	Selectable Range or Selections	Default Value	Setting
Basic settings > Baud rate	1200/2400/4800/9600/19200/38400	9600	
Basic settings > Data length	7/8	8	
Basic settings > Parity	Odd/Even/None	Even	
Basic settings > Handshaking	Off:Off/XON:XON/XON:RS/CS:RS	Off:Off	
Basic settings > Address	1 to 99	1	
Basic settings > Protocol	Normal/Modbus/Modbus-M	Normal	
Modbus master > Basic settings > Read cycle	125ms/250ms/500ms/1s/2s/5s/10s	1s	
Modbus master > Basic settings > Timeout	125ms/250ms/500ms/1s/2s/5s/10s/1min	1s	
Modbus master > Basic settings > Retrials	Off/1/2/3/4/5/10/20	1	
Modbus master > Basic settings > Inter-block delay	Off/5ms/10ms/15ms/45ms/100ms	Off	
Modbus master > Basic settings > Auto recovery	Off/1min/2min/5min/10min/20min/30min/1h	2min	
Master command number	1-8/9-16	1-8	
Command settings	Off/R/R-M/W/W-M	Off	
Command settings > Master > First	Depends on the command type.	–	
Command settings > Master > Last	Depends on the command type.	–	
Command settings > Slave > Address	1 to 247	1	
Command settings > Slave > Registers	Numerical value	30001	
Command settings > Slave > Type	INT16/UINT16/INT32_B/INT32_L/UINT32_B/ UINT32_L/FLOAT_B/FLOAT_L	INT16	

Status relay

Setup Item	Selectable Range or Selections	Default Value	Setting
Memory/Media status	On/Off	Off	
Measurement error	On/Off	Off	
Communication error	On/Off	Off	
Memory stop	On/Off	Off	

End

Setup Item	Selectable Range or Selections	Default Value	Setting
Do you want to store and make the new settings take effect?	Yes/No/Cancel	–	